

Lafferty[®]
EQUIPMENT MANUFACTURING INC.

CATALOG 13

**Pressure Washer Foamers and Sprayers
with Selection Guide
& Soft Wash Airless Foam Wands**

www.LaffertyEquipment.com

5614 Oak Grove Road • North Little Rock, AR 72118

Phone: 800-999-2820 / 501-851-2820 • Fax Orders: 800-699-3719

Do More with Your Pressure Washer

Do more than just add another accessory to your pressure washer. Turn it into the hub of a thriving, versatile chemical cleaning system that lets you do more — Do more types of jobs. Do jobs faster. Work more efficiently. Save labor costs. Save water and chemical. Be ecologically responsible.

The thought behind Lafferty pressure washer equipment is to make life easier and better for the commercial pressure/power washer contractor and other serious pressure washer users at home or on the farm or ranch who are looking for professional results.



In particular, Lafferty foam applicators for pressure washers let you harness the power of your pressure washer in ways not possible with standard spraying accessories.

FOAM ADVANTAGES

Low impact — Foam hits the surface with less force than high pressure spray, letting you clean more delicate surfaces.

Dwell time — Foam clings to surfaces, giving the chemical's cleaning power longer time to work.

Visual assurance of coverage — Foam let's you see instantly the target area is covered. No need to go over areas twice.

Less chemical and water used — Rather than a constant flow of chemical and water across the surface, as with spray applications, foam goes on once then is rinsed after appropriate dwell time, saving chemical and water overall.

Less chemical runoff — The clinging and expanding properties of foam assure a lower volume of chemical is used to begin with, meaning less chemical runoff. The chemical is further diluted when rinsed. *(Follow the chemical manufacturer's instructions for application and safe handling.)*

CHEMICAL DILUTION OPTIONS

Lafferty pressure washer applicators offer three chemical dilution setups to fit the demands of various types of jobs. And the chemical never passes through the pressure washer, protecting your investment. *(Details, next page.)*

Injector connected to pressure washer — Chemical is injected into the high pressure water stream as it exits your pressure washer.

Multi-application injector system between pressure washer and application point — Alternate between foam and spray and rinse with the turn of a ball valve using one or two chemicals, depending on the model.

Injector at hose end — The injector and the hose-end applicator are all in one so chemical is injected just before application and only water flows through your hose. Switch from chemical application to rinsing with no need to clear chemical from the hose. Models feature either an attached, 32 ounce chemical bottle or chemical suction tubing that draws from any detached container.

Chemical Dilution Considerations

Lafferty pressure washer applicators are offered with several chemical dilution setups to fit the demands of various types of jobs. Below are brief details about the different chemical dilution configurations.

Injector (Venturi) Mounted Close to or Attached to Pressure Washer — The venturi chemical applicator/injector can be connected directly to the pressure washer output or mounted to the pressure washer frame or a nearby surface and connected with a short jumper hose. Chemical concentrate is close by. Diluted chemical solution flows through the discharge hose and is projected through the nozzle. High Pressure Bypass Foamers/Sprayers are equipped with a mounting base for this type arrangement, but are often set up with a longer jumper hose between the washer and the Bypass unit (see next illustration below).

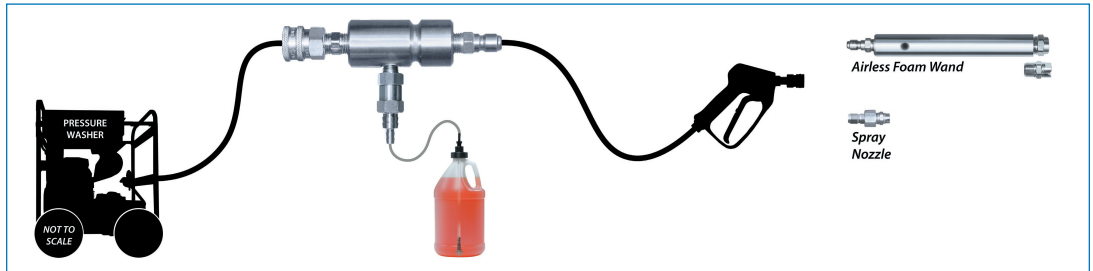

Injector (Venturi) System Between Pressure Washer and Application Point — When you desire to extend your reach further than the standard discharge hose allows, a jumper hose can be connected between the pressure washer and the applicator unit. This setup keeps the ball valve controls on the unit close at hand for alternating between foam or spray or rinse functions and keeps the discharge hose to a manageable length for clearing chemical from the hose when changing to rinse mode. This is a common setup for Lafferty Bypass Airless Foam/Spray Systems (available in one or multi-chemical configurations).

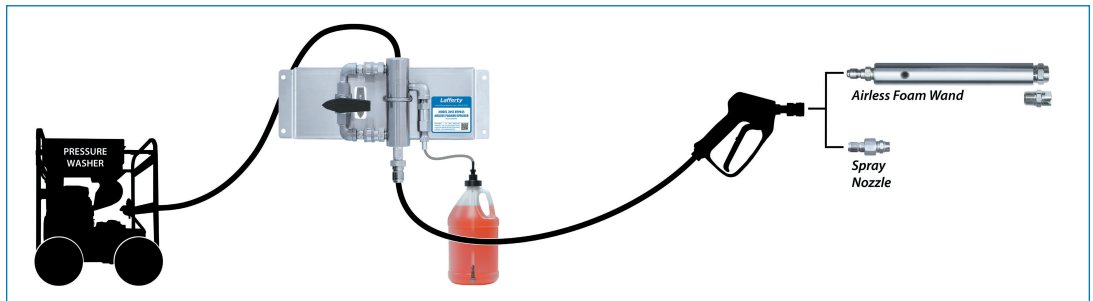

Double Bypass Airless Foam/Spray Systems provide all of the benefits of a Bypass Foamer/Sprayer with the added diverter ball valve to control pressure, flow and foam throw distance. During chemical application, water pressure and flow decreases incrementally as the diverter valve is opened more and more, sending water back to a tank so the unit operates at 5 GPM or less.

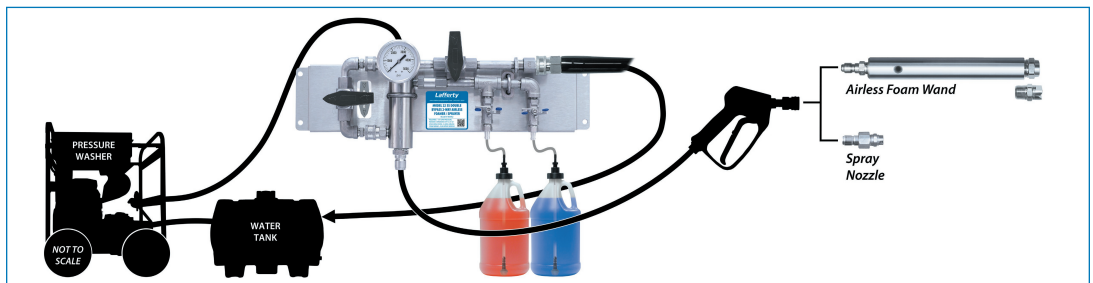

Injector (Venturi) at Hose End — Hose-End & Compact Foamers/Sprayers inject chemical into the water stream just before application so only water flows through the hose and trigger gun. Available with an attached 32 ounce chemical bottle or chemical suction tubing to draw from a detached user-supplied container.



Selection Guide — Lafferty Pressure Washer Equipment

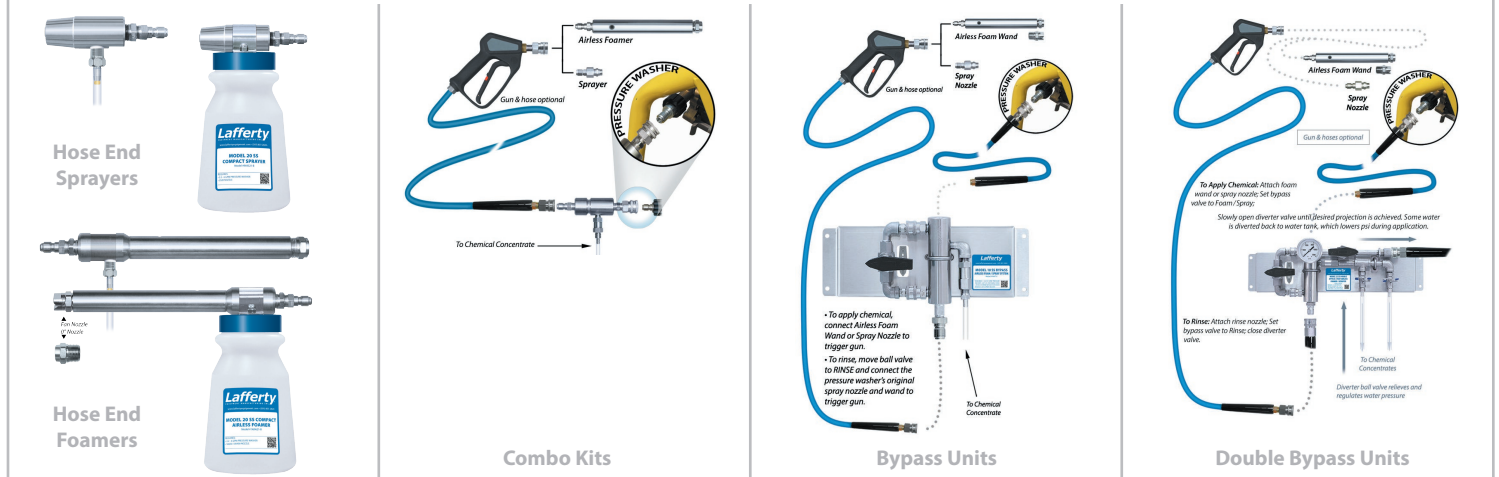

Model #	Description	Required Volume of Pressure Washer	Strongest Dilution Ratio*	Max. Foam Throw (feet)**	Number of Chemical Pickups	Chemical Diluted at Pressure Washer	Discharge Hose Max. Length***	Bottle Attachment	Application Nozzles Included			
									Foaming		Spraying	
									Fan Nozzle	0° Nozzle	Fan Nozzle	
Hose-End Sprayers												
969520	Model 20 SS Hose End Sprayer	2.2 - 5.5 GPM	7:1 @ 4 GPM	N/A	1	✗	N/A	✗	N/A	N/A	✓	
969521-B	Model 20 SS Compact Sprayer	2.2 - 5.5 GPM	7:1 @ 4 GPM	N/A	1	✗	N/A	✓	N/A	N/A	✓	
Hose-End Foamers												
969620	Model 20 SS Hose End Airless Foamer	2.2 - 5.5 GPM	7:1 @ 4 GPM	25'	1	✗	N/A	✗	✓	✓	N/A	
969620HC	Model 20 SSHC Hose End Airless Foamer	2.2 - 5.5 GPM	3.5:1 @ 4 GPM	20'	1	✗	N/A	✗	✓	✓	N/A	
969621-B	Model 20 SS Compact Airless Foamer	2.2 - 5.5 GPM	7:1 @ 4 GPM	25'	1	✗	N/A	✓	✓	✓	N/A	
Combo Kits												
969710	Model 10 SS Combo Airless Foamer / Sprayer Kit	2.2 - 3.4 GPM	7:1 @ 3 GPM	20'	1	✓	200'	N/A	✓	✓	✓	
969720	Model 20 SS Combo Airless Foamer / Sprayer Kit	3.5 - 5.5 GPM	7:1 @ 4 GPM	25'	1	✓	200'	N/A	✓	✓	✓	
969720HC	Model 20 SSHC Combo Airless Foamer / Sprayer Kit	3.5 - 5.5 GPM 3.5 - 4.0 GPM Optimal	5:1 @ 4 GPM	20'	1	✓	200'	N/A	✓	✓	✓	
Bypass Units												
969711	Model 10 SS Bypass Airless Foamer / Sprayer	2.2 - 3.4 GPM	7:1 @ 3 GPM	20'	1	✓	200'	N/A	✓	✓	✓	
969712	Model 10 SS Bypass 2-Way Airless Foamer / Sprayer	2.2 - 3.4 GPM	7:1 @ 3 GPM	20'	2	✓	200'	N/A	✓	✓	✓	
969751	Model 20 SS Bypass Airless Foamer / Sprayer	3.5 - 5.5 GPM	7:1 @ 4 GPM	25'	1	✓	200'	N/A	✓	✓	✓	
969752	Model 20 SS Bypass 2-Way Airless Foamer / Sprayer	3.5 - 5.5 GPM	7:1 @ 4 GPM	25'	2	✓	200'	N/A	✓	✓	✓	
969753	Model 20 SS Bypass 3-Way Airless Foamer / Sprayer	3.5 - 5.5 GPM	7:1 @ 4 GPM	25'	3	✓	200'	N/A	✓	✓	✓	
Double Bypass Units												
969762	Model 22 SS Double Bypass 2-Way Airless Foamer / Sprayer	5.5 - 10+ GPM	7:1 @ 4 GPM	25' Adjustable	2	✓	200'	N/A	✓	✓	✓	

Details are specified on a mid-range pressure washer. Model 10 units @ 3.0 GPM. Model 20 and 22 units @ 4.0 GPM. ~ * DILUTION RATIOS listed as Parts Water : Parts Chemical. ~ **FOAM THROW distance increases with the volume output of the pressure washer. Smaller metering tips may shorten foam throw. ~ *** Using a narrower or longer than recommended discharge hose between injector and nozzle can negatively affect chemical suction.

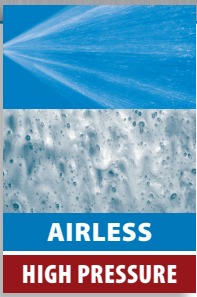

LAFFERTY STAINLESS STEEL COMPACT SPRAYERS AND AIRLESS FOAMERS

are machined stainless steel venturis that quick connect to the trigger gun of a pressure washer and draw chemical and air to create clinging wet foam or a chemical spray. More aggressive chemicals may be used since *no chemical passes through the pressure washer pump, hose or trigger gun.*

These rugged applicators come with everything needed to turn your pressure washer into a versatile foamer / sprayer system — stainless steel quick connect fittings, 32 oz. chemical bottle and metering tips,

STAINLESS STEEL COMPACT SPRAYERS AND AIRLESS FOAMERS

REQUIRES: 1000 PSI WATER (MINIMUM) AND CHEMICAL CONCENTRATE



- Lafferty Stainless Steel Compact Sprayers and Airless Foamers accurately dilute chemical concentrates and produce, respectively, either a light or heavy spray or a high quality airless foam.
- All stainless steel injectors and foamers with stainless steel nozzles and quick disconnect fittings
- Ideal for numerous vehicle wash/detailing applications where use of a pressure washer is preferred

Stainless Steel Compact Sprayers

- Fan pattern for quick coverage, up close; Remove the nozzle for distance.
- Quickly change from spraying to rinsing.

REQUIREMENTS / SPECIFICATIONS

Water Flow Rate *minimum* **1000 PSI** **68.9 bar**
 Model 20 2.2–5.5 gpm 8.3–20.8 lpm

Includes

- All stainless steel construction: injector, quick connect plug, nozzle protector and fan nozzle
- 32 oz. heavy duty, wide-mouth HDPE bottle
- Color coded metering tips for multiple dilution ratios
- Metering tip driver



Model #	Description
969521-B	Model 20 SS Compact Sprayer

Stainless Steel Compact Airless Foamers

- Draw chemical concentrate from the attached, 32 oz. bottle
- Foam is created instantly by the stainless steel venturi airless foam wand
- Two foam nozzles: Fan nozzle for quick coverage, up close; zero degree for added distance — Foam throw up to 25 ft.
- Quickly change from foaming to rinsing.

REQUIREMENTS / SPECIFICATIONS

Water Flow Rate *minimum* **1000 PSI** **68.9 bar**
 Model 20 2.2–5.5 gpm 8.3–20.8 lpm

Includes:

- All stainless steel construction: foamer body, quick connect plug, airless foam wand and nozzles
- Fan and 0° foam nozzles
- 32 oz. heavy duty, wide-mouth HDPE bottle
- Color coded metering tips for multiple dilution ratios
- Metering tip driver



Model #	Description
969621-B	Model 20 SS Compact Airless Foamer

Lid Color Options for Stainless Steel Compact Foamers & Sprayers



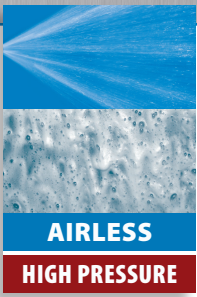

LAFFERTY HOSE END AIRLESS FOAMERS AND SPRAYERS are machined stainless steel venturis that quick connect to the trigger gun of a pressure washer and draw chemical and air to create clinging wet foam or a chemical spray. More aggressive chemicals may be used since *no chemical passes through the pressure washer pump, hose or trigger gun.*

These rugged applicators come with everything needed to turn your pressure washer into a versatile foamer/sprayer system — metering tips, quick connect fittings, clear tubing, and strainer.

Possible uses include: •Vehicle cleaning •Roof/siding/window cleaning •Masonry cleanup •Wood deck/fence cleaning •Parking lot/drive way cleaning •Lawn and Garden chemical applications

STAINLESS STEEL HOSE END AIRLESS FOAMERS AND SPRAYERS

REQUIRES: 1000 PSI WATER (MINIMUM) AND CHEMICAL CONCENTRATE

Hose End Airless Foamers

- Draw chemical concentrate from any chemical container and dilute it to the required ratio.
- Foam is created instantly by the stainless steel venturi airless foam wand
- Two foam nozzles: Fan nozzle for quick coverage, up close; zero degree for added distance
- Quickly change from foaming to rinsing.
- Foam throw up to 25 ft. (up to 20 ft. for HC models)
- HC model for high concentrate solutions up to a strong 3.5:1

Hose End Sprayers

- Draw chemical concentrate from any chemical container and dilute it to the required ratio.
- Fan pattern for quick coverage up close; Remove the nozzle for distance.
- Quickly change from spraying to rinsing.

REQUIREMENTS / SPECIFICATIONS

Water Flow Rate	minimum	1000 PSI	68.9 bar
Model 20	2.2–5.5 gpm		8.3–20.8 lpm

Includes:

- All stainless steel construction: Injector or foamer body, quick connect plug, airless foam wand (969620, 969620HC) and nozzles
- Fan and 0° foam nozzles (969620) or fan spray nozzle (969520)
- Color coded metering tips (20 standard — 5 for HC models)
- Metering tip driver

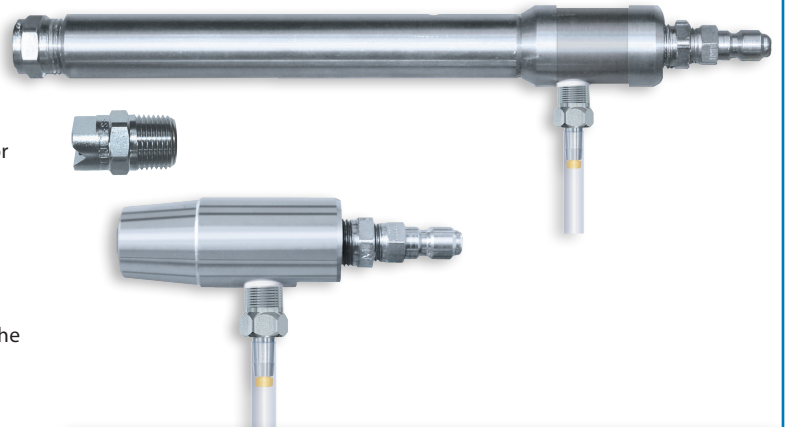

Model #	Description
969620	Model 20 SS Hose End Airless Foamer
969620HC*	Model 20 SSHC Hose End Airless Foamer
969520	Model 20 SS Hose End Sprayer
Optional Jug Lid with Suction Tube (See page 26 for details.)	
709101	Safe Flow Lids™ for 1 Gallon Jugs and 5 Gallon Pails
807069	3/8" x 50' HP Hose, HP Trigger Gun and 1/4" QD Socket

*HC (High Concentrate)

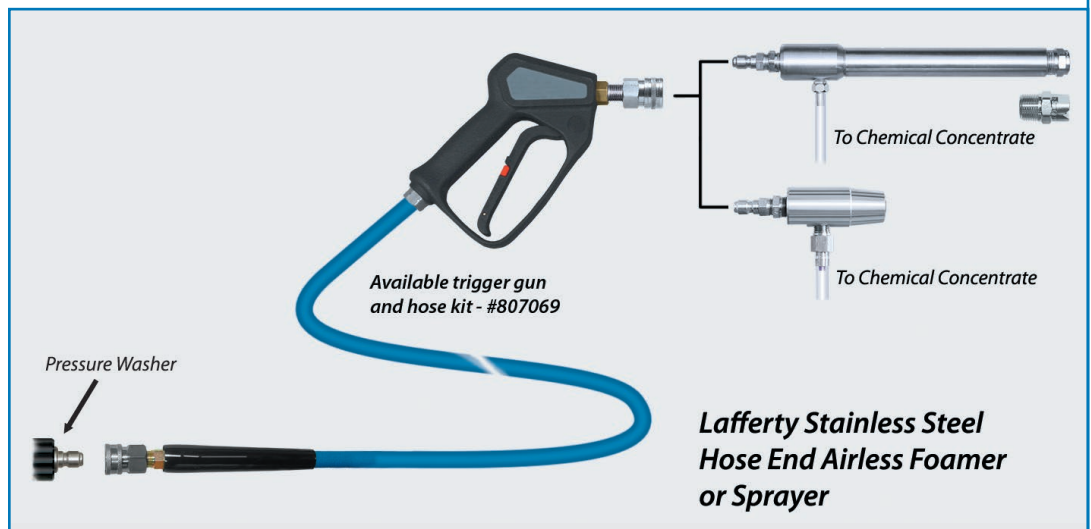

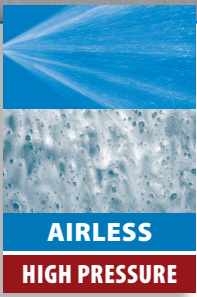

LAFFERTY COMBO AIRLESS FOAMER / SPRAYER KITS are machined stainless steel venturi injectors that quick connect to a pressure washer and include a venturi foam wand and a spray nozzle that quick connect to a trigger gun. The injector draws chemical concentrate from any chemical container and dilutes it to the required ratio.

These kits come with everything needed to turn your pressure washer into a versatile foamer / sprayer system — metering tips, quick connect fittings, clear tubing, and strainer.

No chemical passes through the pressure washer pump.

STAINLESS STEEL COMBO AIRLESS FOAMER / SPRAYER KITS

REQUIRES: 1000 PSI WATER (MINIMUM) AND CHEMICAL CONCENTRATE

- Draw chemical concentrate from any chemical container and dilute it to the required ratio.
- The stainless steel airless foam wand instantly creates wet clinging foam.
- Two foam nozzles: Fan nozzle for quick coverage, up close; zero degree for added distance
- The stainless steel spray nozzle applies non-foaming chemicals.
- **Model 10:** Foam throw up to 20 ft.
- **Model 20:** Foam throw up to 25 ft. (up to 18 ft. for HC models)
- HC model for high concentrate solutions, especially roof cleaning @ 5:1 and 9:1 dilution ratios @ 3.5-4.0 GPM.

REQUIREMENTS / SPECIFICATIONS

Water Flow Rate	minimum	1000 PSI	68.9 bar
Model 10	2.2 to 3.4 gpm	8.3 to 12.9 lpm	
Model 20	3.5-5.5 gpm	13.2-20.8 lpm	

Includes:

- All stainless steel construction: Injector, quick connect plugs and socket, airless foam wand and nozzles
- Fan and 0° foam nozzles and fan spray nozzle
- Color coded metering tips for up to 21 dilution ratios and tip driver

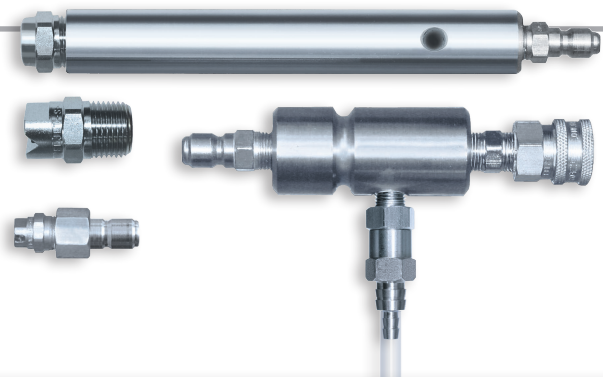

Model #	Description
969710	Model 10 SS Combo Airless Foamer / Sprayer Kit
969720	Model 20 SS Combo Airless Foamer / Sprayer Kit
969720HC*	Model 20 SS HC Combo Airless Foamer / Sprayer Kit
Optional Jug Lid with Suction Tube (See page 26 for details.)	
709101	Safe Flow Lids™ for 1 Gallon Jugs and 5 Gallon Pails
807069	3/8" x 50' HP Hose, HP Trigger Gun and 1/4" QD Socket

*HC (High Concentrate)

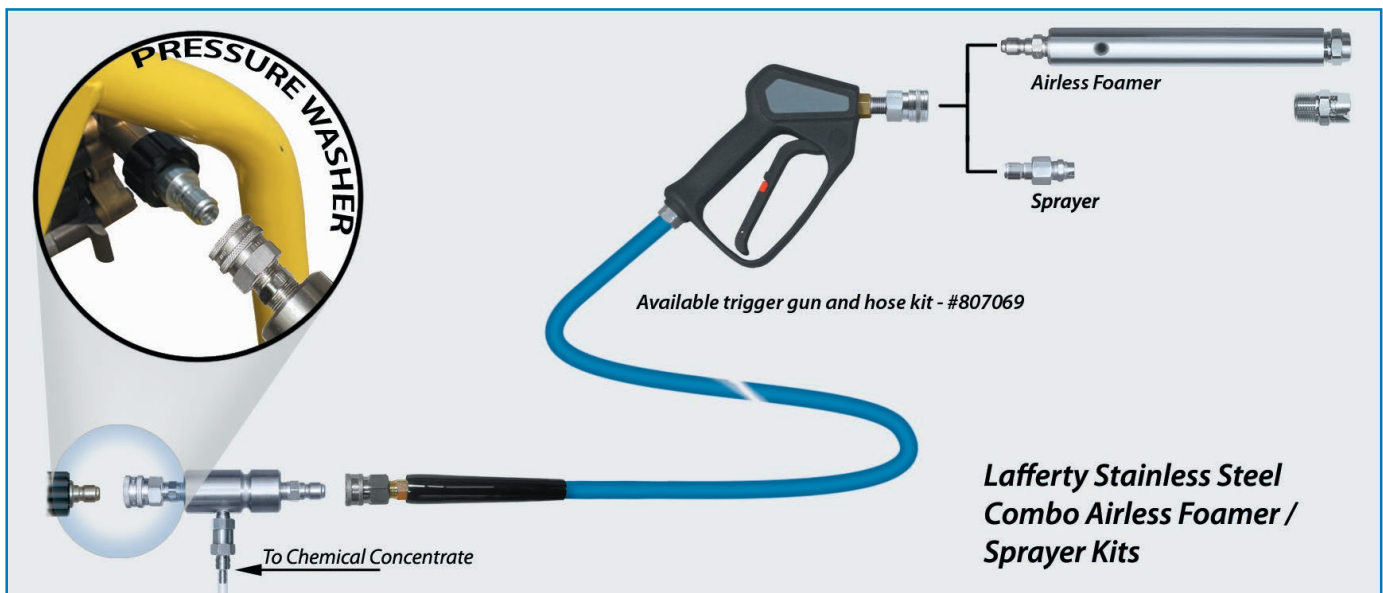

Available trigger gun and hose kit - #807069

**Lafferty Stainless Steel
Combo Airless Foamer /
Sprayer Kits**



LAFFERTY HIGH PRESSURE BYPASS AIRLESS FOAM / SPRAY SYSTEMS are machined stainless steel combination applicators that project chemical foam or spray onto any surface and rinse. To alternate between foam or spray, connect the airless foam wand or spray nozzle and open the ball valve for the selected chemical. Rinse at full volume and pressure by opening the bypass ball valve.

These high pressure water-driven venturi systems accurately dilute chemical concentrates to required ratios and project a spray or high quality, wet foam onto any surface without the need for compressed air.

Offered in multiple configurations to apply one to four chemicals or dilution ratios. The Double Bypass 2-Way model allows control of pressure, flow and foam throw distance to meet variable application requirements.

BYPASS AIRLESS FOAM / SPRAY SYSTEMS

REQUIRES: 1000 PSI WATER (MINIMUM) AND CHEMICAL CONCENTRATE

- Produces airless foam or spray, using high pressure water systems
- Select the model that fits the flow rate of the water system or pressure washer (see *Requirements/Specifications*)
- Alternate between foam / spray and rinse with the turn of a ball valve
- No need to disconnect injector for rinsing
- Rinse at full volume and pressure
- Stainless steel construction
- Select the stainless steel spray nozzle to spray non-foaming chemicals.
- Two foam nozzles: Fan nozzle for quick coverage, up close; zero degree for added distance; all with quick disconnect fittings
- Pressure washer is protected — no chemical passes through the pump
- Choice of 1,2, 3 or 4 chemical pickup tubes

REQUIREMENTS / SPECIFICATIONS

Water Flow Rate	minimum	1000 PSI	68.9 bar
Model 10	2.2 to 3.4 gpm	8.3 to 12.9 lpm	
Model 20	3.5–5.5 gpm	13.2–20.8 lpm	

Includes

- Machined stainless steel injector body
- Stainless steel mounting bracket
- Stainless steel bypass ball valve
- Stainless steel quick disconnect fittings
- Color-coded metering tips (20)
- Metering tip driver
- Stainless steel airless foam wand with zero degree and fan nozzles
- Stainless steel spray nozzle
- Select models include a 50' high-pressure hose (969751-C50 and 969752-C50)

Option

- **#336340 HP Water Pressure/Flow Test Kit** — This high pressure gauge kit installs in-line between the pump and injector to confirm operating pressure for setup and metering tip calculations. 3/8" threaded inlet and discharge.



Stainless steel airless foam wand with zero degree and fan nozzles; spray nozzle for non-foaming chemicals; each with quick disconnect plug.

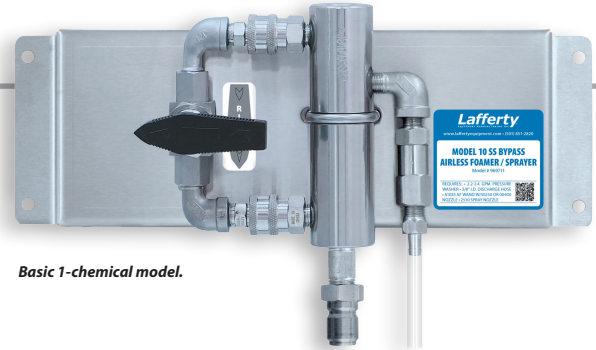

Basic 1-chemical model.

Model #	Description
969711	Model 10 SS Bypass Airless Foam / Spray System
969712	Model 10 SS Bypass 2-Way Airless Foam / Spray System
969751	Model 20 SS Bypass Airless Foam / Spray System
969751-C50	(includes 50' hose)
969752	Model 20 SS Bypass 2-Way Airless Foam / Spray System
969752-C50	(includes 50' hose)
969753	Model 20SS Bypass 3-Way Airless Foam / Spray System
969754	Model 20SS Bypass 4-Way Airless Foam / Spray System

OPTION

336340-HP HP Water Pressure/Flow Test Kit

(Items shown are not to scale with each other.)



2-Way model ▼

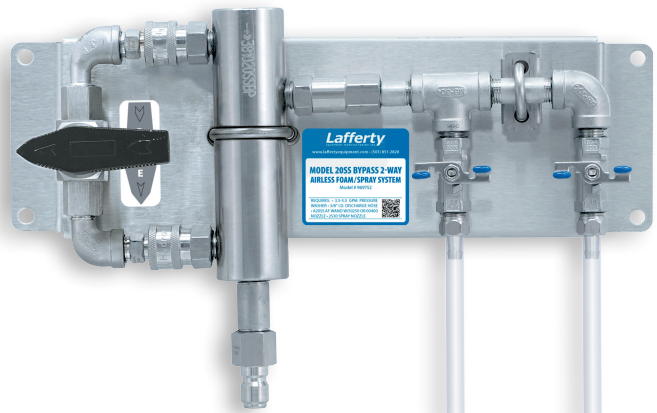

PORTABLE MODEL 20 SS BYPASS 2-WAY AIRLESS FOAM/SPRAY SYSTEM

REQUIRES: 400 TO 2500 PSI WATER AND CHEMICAL CONCENTRATE

- This complete system includes all required components on a heavy-duty, all-stainless-steel cart with non-marking tires and front, swivel casters.

REQUIREMENTS / SPECIFICATIONS

Water Flow Rate *minimum* **1000 PSI** **68.9 bar**
 3.72 gpm 14.08 lpm

Includes

- Machined stainless steel injector body with water pressure gauge
- 4-wheel, stainless steel cart with integrated hose rack
- Non-marking tires and front, stainless steel swivel casters
- Two 5-gallon, round, stainless steel jug racks (square optional)
- Stainless steel bypass ball valve and two chemical ball valves
- Stainless steel quick disconnect fittings
- Color-coded metering tips (20)
- Metering tip driver
- Quick connect high pressure discharge hose (3/8" x 50') with all-stainless-steel fittings
- Trigger gun with wand and quick-connect socket for attachments
 - Quick-connect machined stainless steel airless foam wand with fan and zero degree nozzles
 - Quick-connect fan pattern spray nozzle (2520)
 - Quick-connect focused rinse nozzle (0511)
- Two quick-connect storage mounts for attachments



Model #	Description
969775	Portable Model 20 SS Bypass 2-Way Airless Foam / Spray System

3-Way model ▼

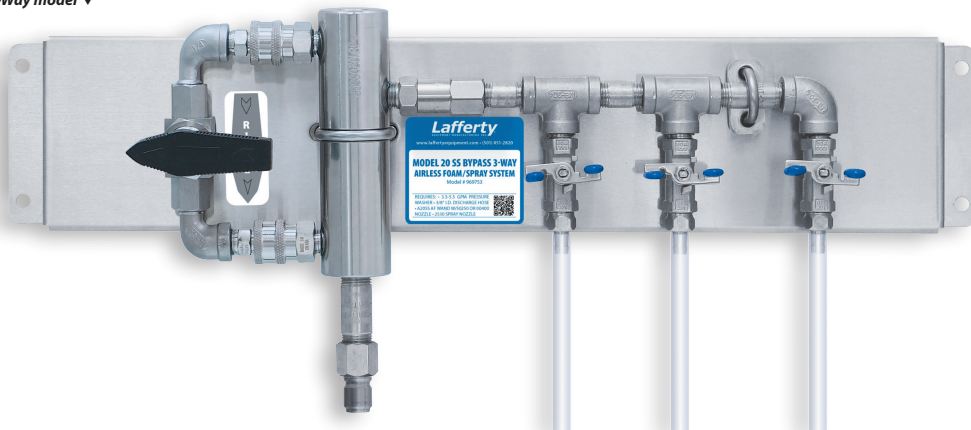

4-Way model ▼



Double Bypass
2-Way Airless Foam /
Spray System



(See page 10)

MODEL 22 SS DOUBLE BYPASS 2-WAY AIRLESS FOAM/SPRAY SYSTEM

REQUIRES: 1000 PSI WATER (MINIMUM) AND CHEMICAL CONCENTRATE

- Produces airless foam or spray, using high pressure water systems
- Alternate between foam / spray and rinse with the turn of a ball valve
- No need to disconnect injector for rinsing
- Foam and spray projection is adjustable using the diverter ball valve that decreases pressure and flow incrementally the more it is opened so the unit operates at 5 GPM or less, sending diverted water back to the supply tank.
- Applies two separate chemicals or two different concentrations of the same chemical
- To rinse at full volume and pressure - simply open the bypass ball valve, close the diverter valve, and connect your original rinse nozzle. Stainless steel construction
- Select the stainless steel spray nozzle to spray non-foaming chemicals.
- Two foam nozzles: Fan nozzle for quick coverage, up close; zero degree for added distance
- Pressure washer is protected — no chemical passes through the pump

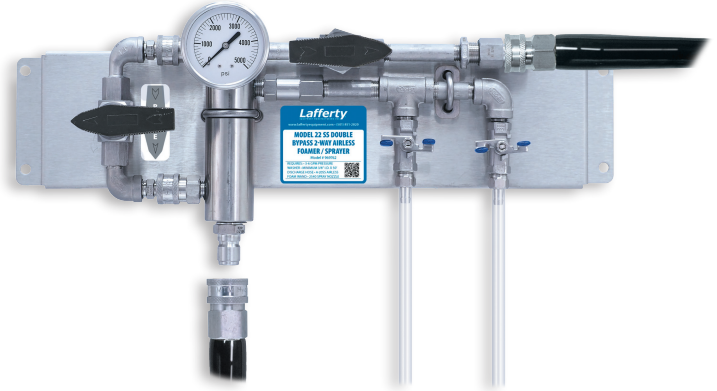

Model #	Description
969762	Model 22 SS Double Bypass 2-Way Airless Foam/Spray System

REQUIREMENTS / SPECIFICATIONS

Water Flow Rate *minimum* **1000 PSI** **68.9 bar**
 Double Bypass 5.5–10+ gpm 20.8–37.8+ lpm

Includes

- Machined stainless steel injector body
- Stainless steel mounting bracket
- Stainless steel bypass ball valve
- Stainless steel diverter ball valve with 25' high pressure diverter hose
- Stainless steel quick disconnect fittings
- Color-coded metering tips (20)
- Metering tip driver
- Stainless steel airless foam wand with zero degree and fan nozzles
- Stainless steel spray nozzle

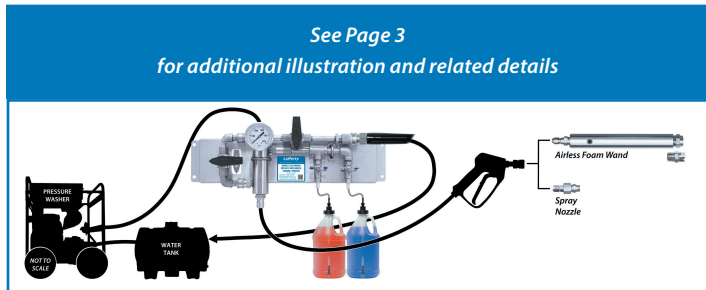
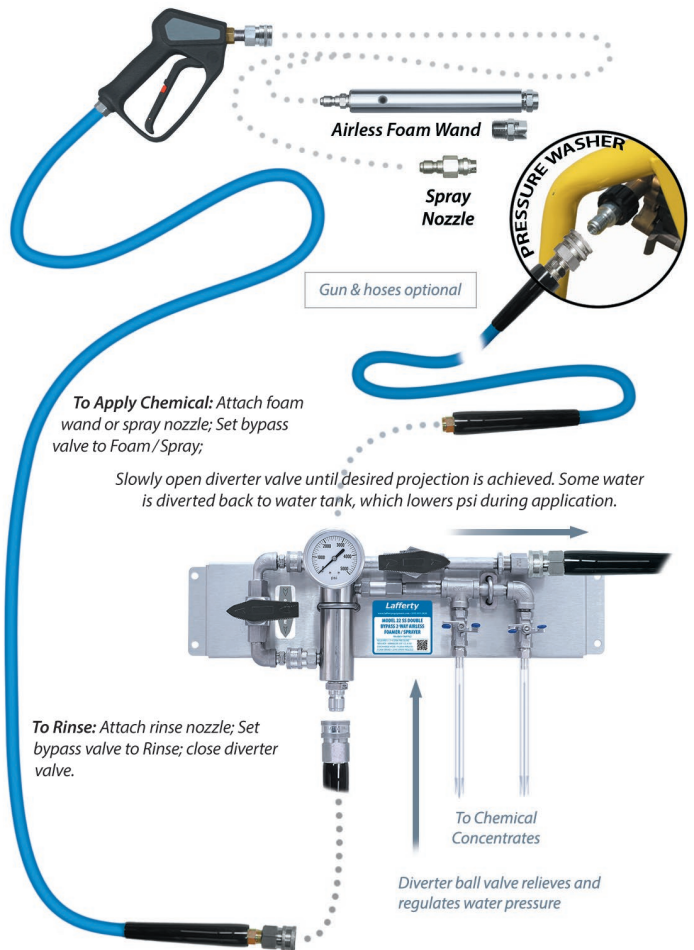

PRESSURE WASHER ACCESSORIES AND ACCESSORY PARTS

Presented here are a select number of pressure washer accessories and related parts that our professional pressure washer customers find useful, including nozzles, quick disconnect fittings, trigger guns and hoses. If a part is not listed here that you see in this or another Lafferty catalog or on our web site, please [contact us to request availability and a quote](#).

STAINLESS STEEL AIRLESS FOAM WAND

- Lafferty Stainless Steel Airless Foam Wands are machined venturis that draw in atmospheric air to produce wet clinging foam, and are designed for use with pressure washers equipped with a downstream chemical injector.
- Simply quick connect the stainless steel airless foam wand to the trigger gun of a pressure washer
- Foam is created instantly by the venturi airless foam wand from pre-diluted, foaming chemical.
- Foam quality and foam throw will depend upon the chemical, the dilution ratio and the water flow and pressure generated by the pressure washer.



REQUIREMENTS / SPECIFICATIONS

Pressure Washer Flow Rate *min. 1000 PSI / 68.9 bar*

969400 / 969402 3 to 4 gpm 11.3 to 15.1 lpm

Includes:

- Machined stainless steel airless foam wand
- Stainless steel quick connect plug
- Machined stainless steel fan nozzle (removable) - 969402
- Two nozzles: 0° and 50250 fan nozzles - 969390

Model #	Description
969400*	A-40 SS Airless Foam Wand
969402*	A-40 SS Airless Foam Wand w/Fan Nozzle

** Flow rate equivalent for common black detergent nozzles (40° nozzles)*



Model #	Description
Hose Assembly	
807069	3/8" x 50' HP Hose, HP Trigger Gun and 1/4" QD Socket <i>Blue, non-marking hose, 3/8" internal diameter – minimum acceptable for all Lafferty pressure washer applicators. Includes trigger gun - #320438; stainless steel nipple (1/4" x 1 1/2") - #429415SS; stainless steel QD socket (1/4") - #350423</i>
Trigger Guns	
320438	Gun, ST-2305, Easy Trigger <i>12 GPM, 5000 PSI, EPDM O-ring, SS Inlet, Brass Body, Plastic Housing</i>
320440	Gun, ST-2700, SS, Easy Trigger <i>5000 PSI, 12GPM Max 303SS housing, SS Components, Peek piston, Viton Seals, Glass filled PP Cover</i>
3/8" QD Plug and Socket	
350450	QD, SS, Plug, 3/8" MPT <i>5500 PSI Max 304SS</i>
350446	QD, SS, Socket, 3/8" FPT <i>5500 PSI Max 304SS Body, 304SS Spring, 440SS Balls, EPDM O-ring</i>
1/4" QD Plug and Socket	
350421	QD, SS, Plug, 1/4" FPT <i>5000 PSI Max 304SS</i>
350423	QD, SS, Socket, 1/4" <i>5000 PSI Max 304SS Body, 304SS Spring, 440SS Balls, EPDM O-ring</i>
Insulating Hand Grip for Spray Wand	
536500	Insulator For 1/4" SS Wand <i>15 inches; Vented grip aids control and insulates hands against hot and cold extremes of the metal wand. Easily adjusts anywhere on the wand / lance for desired ergonomic comfort.</i>

Airless Foam Wands for Softwash Pump Systems

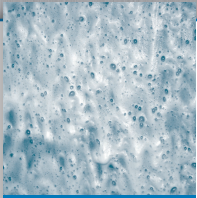

AIRLESS

PUMP FED AIRLESS FOAM WANDS are designed for use with pump systems that can supply solution to the wand at 40-125 PSI. Chemical solution, supplied through the pump or an in-line injector downstream from the pump, flows through the airless foam wand, which draws in atmospheric air to create and project wet, clinging foam.

These wands can be used with any pump that provides the required solution pressure at the wand:*
 • Water Driven Proportioning Pump • Electric Pump • Air Operated Double Diaphragm Pump

PUMP FED AIRLESS FOAM WANDS

REQUIRES: 40-125 PSI SOLUTION PRESSURE,* PRE-DILUTED (RTU) CHEMICAL SOLUTION

- No compressed air required to create clinging, wet foam
- Foaming expands the chemical, increases chemical contact time and provides visual assurance of coverage, reducing over-application
- Machined from solid polypropylene stock
- Available in five flow rates to suit the requirements of specific jobs



◀ #6 Bullet - Model 536106-6
 ▶ #10 Bullet - Model 536110-6



◀ PF 39SS - Model 535539SS
 ▶ PF 31SS - Model 535531SS
 ▶ Polypropylene Models: - PF31 - 535531 | PF39 - 535539



▼ PF 314 - Model 536619 | PF 316 - Model 536621 | PF 416 - Model 536622

Bullet™ Foam Nozzles

- Low-flow airless foamers that can be adjusted to project a wide angle for close-up, quick coverage or a zero degree stream for increased distance.
- Good for close application up to several feet.
- Especially good for applications onto soft or delicate surfaces: wood decks, fences, outdoor furniture, doors; plants; fabric awnings, umbrellas, vehicle covers; RV roofs and other exterior surfaces; etc.

PF (Pump Fed) Foam Wands

• PF39 and PF31

- Medium flow airless foam wands that project a zero degree pattern with a usable foam throw of up to 6 feet and 8 feet, respectively, at 40 PSI solution pressure.
- Foam throw range increases at higher pressures
- Choice of two flow rates provides efficient coverage for small or large areas
- Available in polypropylene or stainless steel.

• PF316

- A high flow airless foam wand that has a usable foam throw of up to 20 feet.
- Best results are obtained when the solution pressure is about 60 PSI.
- The high flow rate and long range make this wand the ideal choice for super-fast coverage of large areas or surfaces.

• PF416

- A high flow airless foam wand that has a usable foam throw up to 20 feet or more, depending on water pressure and other conditions.
- Best results are obtained when the solution pressure is about 60 PSI.
- Has a high flow rate of 8 gpm at 60 PSI water pressure.

Model #	Description
536106-6	#6 Bullet Foam Nozzle, 1/2" FPT
536110-6	#10 Bullet Foam Nozzle, 1/2" FPT
535539	Wand, PP, Airless Foam, PF39
535539SS	Wand, SS, Airless Foam, PF39SS
535531	Wand, PP, Airless Foam, PF31
535531SS	Wand, SS, Airless Foam, PF31SS
536621	Wand, PP, Airless Foam, PF316
536622	Wand, PP, Airless Foam, PF416

*Solution pressure requirements are for the wand at the hose end. Available solution pressure at the wand will be less than the water/solution pressure output at the pump, with pressure reduction being based on length of hose and if an in-line injector is used downstream from the pump.

REQUIREMENTS / SPECIFICATIONS

Solution Pressure at Wand*	40 - 125 PSI	2.8 - 8.6 bar
Wand Flow Rates	@ 40 PSI	@ 2.8 bar
536106-6	0.6 gpm	2.3 lpm
536110-6	1.0 gpm	3.8 lpm
535539	1.5 gpm	5.7 lpm
535531	2.0 gpm	7.6 lpm
536621	6.3 gpm	23.8 lpm
536622 (@ 60 psi)	8.0 gpm	30.3 lpm

Lafferty Pressure Washer Terminology and Key Benefits Summary

Sprayer	Sprayers apply chemical as liquid spray. Pressure washer sprayers include a fan pattern nozzle for quick application over large areas. The fan nozzle can be removed for zero degree output for longer range. Spray distance is dependent on pressure washer volume.
Airless Foamer	Airless Foamers apply chemical as a wet, foamy lather without compressed air assistance. The Airless Foam Wand draws atmospheric air into the chemical solution. Airless foam is excellent for re-hydrating surface soils to facilitate removal. Most "softwash" applications involve foam due to foam's increased chemical contact time, visual confirmation of coverage, and greatly reduced application pressure.
SS	Stainless Steel — Injectors and foam wands are machined from stainless steel for exceptional durability and the ability to handle temperatures up to 180°F. Other benefits include low maintenance requirements with few or no moving (wear) parts.
HC	High Concentrate — These specialized units produce the strongest dilution ratios possible but with shorter maximum foam throw distance than the non-HC equivalent.
Hose End	Connects directly to pressure washer trigger gun (1/4" quick connect). Injector and nozzle are a single assembly. Easily removed for high pressure rinsing. No limit to hose length from pressure washer. This is the most versatile style of pressure washer equipment, but requires the user to keep the concentrated chemical nearby.
Compact	A type of Hose End unit. Includes an attached bottle for chemical concentrate instead of a long suction tube.
Combo	Injector is separate from the paired foam wand or spray nozzle so the user does not need to carry chemical. For rinsing, switch to the pressure washer's standard nozzle (not included) to stop chemical suction and rinse at reduced pressure or, to rinse at full volume and pressure, also disconnect the injector.
Bypass	Same foam performance and injector requirements as the equivalent Combo unit but includes a valve to bypass the chemical injector and rinse at full volume and pressure.
Double Bypass	Specialized Bypass unit with a diverter valve to relieve excess pressure/volume on pressure washers with flows greater than 5.5 GPM. Excess water volume is diverted directly back into the water tank, allowing the unit to simulate a lower volume pressure washer to reduce water and chemical consumption. The diverter valve can be used to reduce foam, spray, or rinse volume for more controlled close range applications.

◀ Illustrations – See related information, pp. 2-3



FREQUENTLY ASKED QUESTIONS

Below are abridged answers to a few of the questions most often asked. To see the complete answers to these and other questions in our online *Lafferty Learning Center*, scan the QR code above or, if viewing our catalog online, click on any of the questions below.

- **What is the difference between a foamer and sprayer?**
 - Foamers project aerated chemical to increase chemical contact time, reduce wasteful runoff, and provide visual confirmation of coverage...
 - Sprayers project liquid output for non-foaming chemicals or when foaming is not advantageous...
- **What does "airless" foam mean? Will this produce "shaving cream" foam consistency?**
 - Airless Foamers draw atmospheric air into the diluted chemical as it flows through the foam wand to create foam without compressed air...
- **How forceful is the output? Is it suitable for "softwash" applications?**
 - Foam is naturally low pressure and great for cleaning surfaces that may be damaged by high water pressure...
- **What is the maximum foam throw distance possible?**
 - Foam throw distance depends on the model and flow rate of the pressure washer...
- **I already have a chemical injector. Can I buy a foam wand by itself?**
 - Yes, but we can't guarantee performance with a non-Lafferty injector.
 - #969402 A-40 Airless Foam Wand with Fan Nozzle is our most universal substitution for a standard '40' detergent nozzle that is used with many non-Lafferty injectors...

NOTES:

NOTES:

LAFFERTY CATALOG SERIES

• Food & Beverage Processing • Pharmaceutical • Agriculture • General Industrial Applications



1 • Venturi Systems – City Water Pressure

2 • Venturi Systems – Boosted Pressure

3 • Venturi Systems – High Pressure

4 • Compressed Air Operated Systems

5 • Pump Fed Sanitizers, Foamers & Hose Drop Stations

6 • Entryway, Drain & Hand Sanitizing Systems

7 • Foggers and Fogging Systems

Special Applications

8 • Asphalt Release, Acid / Corrosive & Solvent Systems

9 • Chemical Management Systems

10 • Vehicle Wash & Detailing Systems

11 • JanSan / Commercial / Residential Systems

12 • Supermarket / Deli / Small Area Cleaning Systems

