

8 Industrial

- **Asphalt Release Systems**
 - Sprayers
 - Airless Foamers
 - Air Assisted Foamers
 - Drive Thru Systems
- **Acid/Corrosive Systems**
 - Mixing Stations
 - Sprayers
 - Airless Foamers
 - Air Assisted Foamers
 - Air Pump systems
- **Solvent Systems**
 - Mixing Stations
 - Water-driven Sprayers
 - Pump-driven Sprayers
 - Tank Sprayers



Lafferty®

EQUIPMENT MANUFACTURING INC.

CATALOG 8

Industrial

- ASPHALT RELEASE • ACIDS / CORROSIVES • CONCRETE REMOVAL
- ALUMINUM BRIGHTENING • SOLVENTS

Chemical Application Equipment

www.LaffertyEquipment.com

5614 Oak Grove Road • North Little Rock, AR 72118

Phone: 800-999-2820 / 501-851-2820 • Fax Orders: 800-699-3719

Industrial Chemical Application Equipment

When applying harsh chemicals in industrial environments, you need Industrial Strength Chemical Application Equipment, designed to perform reliably within those challenging conditions.

For the tough jobs and the harsh environments, Lafferty offers truly industrial strength systems, optimized to suit a range of different requirements. With numerous options for dilution control, the amount of chemical being applied can be finely managed to ensure that the job gets done with minimal chemical waste.

Lafferty builds quality into every piece of chemical application equipment – from the precision machining of our foamer and sprayer bodies, to the careful selection of heavy-duty components, to the individual testing of every unit. This keeps Lafferty Equipment products working better and longer than any other brand. Once you experience Lafferty quality and performance, you will know that no other brand can be “just like a Lafferty”.

Lafferty's Complete Balanced System Approach

The team at Lafferty Equipment puts more than a century of combined manufacturing and in-the-field experience into every piece of chemical application equipment that we offer. Our approach is to provide a complete, balanced system right out of the box for ease of installation and trouble-free performance.

Our passionate focus on superior quality, outstanding reliability and attention to detail ensures years of consistent operational performance and peace of mind.

Focus on Performance

- Dedicated Research and Development team
- Application-specific designs to create integrated balanced systems
- Discharge hoses (lengths and diameters) and nozzles carefully selected to ensure optimum system performance
- Machined foamer and sprayer bodies engineered for their specific, intended use
- Reliable, precision metering options

Focus on Quality, Reliability and Durability

- Designed to endure heavy usage in industrial settings with minimal maintenance requirements
- Lafferty's proprietary stainless steel and polypropylene components are precision machined on state-of-the-art CNC and traditional machine tools in Lafferty's manufacturing facility in Arkansas.
- Material selection for optimum chemical and industry compatibility, with all wetted parts chemically resistant
- Extensive testing of all finished products

Focus on Service

- Dedicated to superior customer service and support
- Detailed web site and catalog information for equipment selection
- Prompt order shipment
- Comprehensive Installation and Operation Instructions

Asphalt Release Applications

Asphalt paving projects rely on hot mix transport trucks to keep on schedule so the job stays on track. Effective asphalt release agents and application equipment are critical to this mission, whether for the beds of asphalt transport trucks or for drag slat systems in the asphalt plant yard or for pavers or rollers at the paving site.

Lafferty Equipment offers a wide variety of heavy duty application equipment to suit every need.

Asphalt Release Sprayer or Foamer Systems configurations:

- Water driven – Timed and Manual5-7
- Air Pump driven – Timed and Manual 8
- Electric Pump driven – Timed and Manual 9
- Automated Drive-Thru Systems — Air Pump and Electric Pump models
 - DART™ – Push Button Activated 10
 - RADAR™ – Sensor Activated11-12

All include models for concentrated or ready-to-use release agents

Acid / Corrosive, Concrete Removal and Aluminum Brightening Applications

Designed for use with corrosive acids, Lafferty’s wide range of heavy duty Acid and Concrete/Aluminum Brightening systems offer the ability to achieve virtually any desired dilution ratio and apply multiple chemical combinations.

Models include:

- High concentrate Mixing Stations 13
- Water driven Sprayers and Airless Foamers 14
- Water driven Foamers 15-16
- Air Pump driven Sprayers and Foamers17-18
 - Includes timed and manually operated models for concentrated or ready-to-use chemical

Solvent Applications

Lafferty’s Solvent Mixing Stations, Solvent Spray-Alls and Solvent Tank Sprayers are suitable for handling many higher-flash-point solvents, including d-limonene.

Models include:

- Stainless Steel Mixing Stations 20
- Water driven Sprayers 20
- Air Pump driven Sprayers 21
- Compressed Air driven Internal Tank Sprayers with ASME rated stainless steel tanks 22



Asphalt Release Application

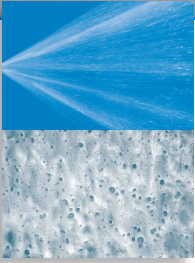

LAFFERTY ASPHALT RELEASE SPRAY-ALLS AND AIRLESS FOAMERS are water-driven venturi systems that accurately dilute asphalt release agents to the required ratios and project an even spray, or airless foam, onto the beds of asphalt trucks or other surfaces.

For driver operated applications, Asphalt Release Sprayers and Airless Foamers are offered as either manual or timed models.

ASPHALT RELEASE SPRAY-ALLS AND AIRLESS FOAMERS

REQUIRES: 35-125 PSI WATER, CHEMICAL CONCENTRATE

- Draw asphalt release agent directly from original shipping containers and accurately dilute it to the required ratio

Spray-Alls

- Project an even spray pattern for quick complete coverage of the truck bed
- 2-Way Spray-Alls allow alternating between two different release agents or two different ratios of the same release agent

Airless Foamers

- For foaming asphalt release agents, these systems project an even foam pattern for quick, complete coverage of the truck bed.
- Foam provides visual confirmation of coverage

Drum Bung Mount Models

- Mount directly to drum bung
- Two set up options
 - Exposed metering tip holder – Chemical tube connects to metering tip holder at top of injector body and draws chemical through the small drum bung opening.
 - Hidden metering tip holder – The metering tip holder is positioned at the bottom of the injector body so the tip holder and chemical tube are hidden in the chemical drum, discouraging unauthorized changes to the metering tip and dilution ratio.

REQUIREMENTS / SPECIFICATIONS

Water Pressure 35 - 125 PSI 2.4 - 8.6 bar

Water Flow Rate up to 1.3 gpm 4.9 lpm

Discharge Hose

ID 1/2 in. 12.7 mm

Length 25 ft. 7.6 m

Electricity (Timed Models) 120v

Includes

- Machined polypropylene injector body
- Color-coded metering tips (20)
- Metering tip driver
- Discharge hose assembly with stainless steel ball valve, wand and nozzle or polypropylene airless foam wand

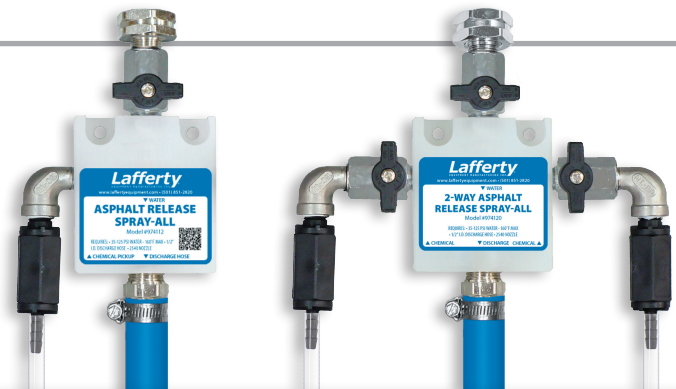

Model #	Description
974112	Asphalt Release Spray-All
974120	2-Way Asphalt Release Spray-All
974114	Asphalt Release Airless Foamer

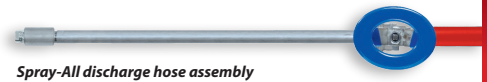

Spray-All discharge hose assembly



Airless Foamer discharge hose assembly



Optional: #536500 Insulator for 1/4" SS Wand Aids gripping and insulates against hot and cold extremes of the metal wand.

Model #	Description
974600	DBM Asphalt Release Spray-All
974700	DBM Asphalt Release Airless Foamer



INDUSTRIAL

TIMED ASPHALT RELEASE SPRAY-ALLS AND AIRLESS FOAMERS

REQUIRES: 35-125 PSI WATER, ELECTRICITY AND CHEMICAL CONCENTRATE

- Timed with push button — An adjustable run timer controls the length of application. An adjustable delay timer keeps the driver from immediately restarting the system, preventing costly over-application.
- Draw asphalt release agent directly from original shipping containers and accurately dilute it to the required ratio
- Projects an even spray pattern for quick complete coverage of the truck bed

REQUIREMENTS / SPECIFICATIONS

Water Pressure	35 - 125 PSI	2.4 - 8.6 bar
Water Flow Rate	up to 2.0 gpm	7.6 lpm
Discharge Hose		
ID	1/2 in.	12.7 mm
Length	25 ft.	7.6 m
Electricity (Timed Models)	120V	

Includes

- Control Box with Run/Delay timers
- Remote push button with 8' power cord
- Machined polypropylene injector body
- Color-coded metering tips (20)
- Metering tip driver
- Discharge hose assembly with stainless steel ball valve, wand and nozzle



Model #	Description
977002	Timed Asphalt Release Sprayer



Spray-All discharge hose assembly



Optional: #536500 Insulator for 1/4" SS Wand Aids gripping and insulates against hot and cold extremes of the metal wand.



AIR ASSISTED

LAFFERTY ASPHALT RELEASE UNI-BODY FOAMERS are water-driven, air-assisted venturi systems that accurately dilute asphalt release agents to the required ratios and project a rich, high quality foam onto the beds of trucks or other surfaces. Foam provides visual assurance of complete coverage and reduces run-off.

ASPHALT RELEASE UNI-BODY FOAMER WITH MANUAL REMOTE

REQUIRES: 35-125 PSI WATER, COMPRESSED AIR AND CHEMICAL CONCENTRATE

- Draws asphalt release agent directly from shipping containers and accurately dilutes it to the required ratio.
- Medium volume foam output
- Manual remote assembly
- Allows the driver to activate application from the platform while the main unit remains close to the chemical container
- Usable foam throw of up to 12 feet
- Covers up to 500 ft.² in 2 minutes

REQUIREMENTS / SPECIFICATIONS

Compressed Air	2.5-6.0 cfm	71.0-170.0 lpm
Water Pressure	35-125 PSI	2.4-8.6 bar
Water Flow Rate	@ 40 PSI	@ 2.8 bar
	1.3 gpm	4.9 lpm
Discharge Hose		
ID	3/4 in.	19.1 mm
Length	25 ft.	12.2 m

Includes

- Machined polypropylene foamer body and remote manifold
- Color-coded metering tips (20) and metering tip driver
- Twinline water and air hose (10 ft.) for manual remote activation
- Discharge hose, open flow polypropylene foam wand and zero degree nozzle

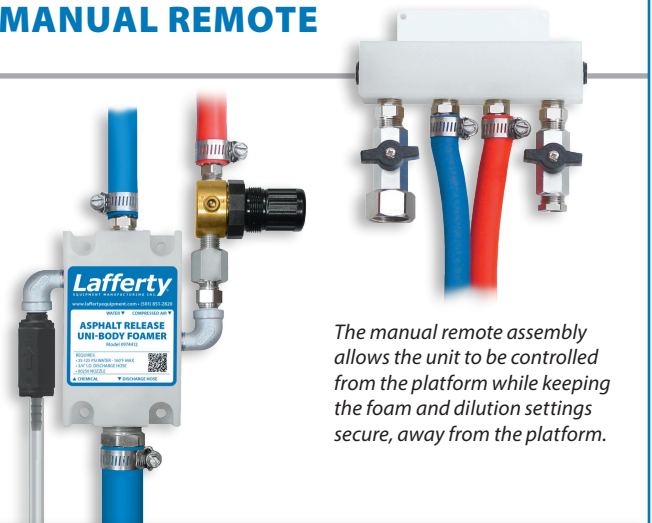

The manual remote assembly allows the unit to be controlled from the platform while keeping the foam and dilution settings secure, away from the platform.

Model #	Description
974412	Asphalt Release Uni-Body Foamer



Upgrade Option for Unit listed above: Stainless Steel Wand upgrade when ordering with unit. Request item # 536603-X.

TIMED ASPHALT RELEASE UNI-BODY FOAMER

REQUIRES: 35-125 PSI WATER, ELECTRICITY, COMPRESSED AIR AND CHEMICAL CONCENTRATE

- Timed models precisely control chemical use
- Draws asphalt release agent directly from shipping containers and accurately dilutes it to the required ratio.
- Timed with push button – An adjustable run timer controls the length of application. A delay timer keeps the driver from immediately restarting the system, preventing costly over application

REQUIREMENTS / SPECIFICATIONS

Compressed Air	2.5-6.0 cfm	71.0-170.0 lpm
Water Pressure	35-125 PSI	2.4-8.6 bar
Water Flow Rate	@ 40 PSI	@ 2.8 bar
	1.3 gpm	4.9 lpm
Discharge Hose		
ID	3/4 in.	19.1 mm
Length	25 ft.	12.2 m

Includes

- Machined polypropylene foamer body
- Metering tip driver
- Color-coded metering tips (20)
- Discharge hose, open flow polypropylene foam wand and matching fan nozzle

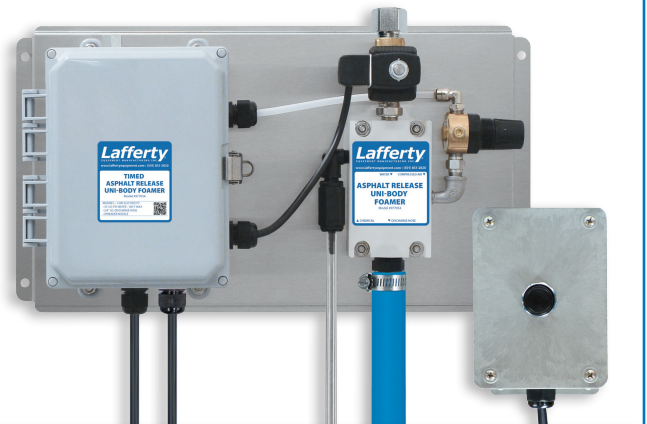

Model #	Description
977034	Timed Asphalt Release Uni-Body Foamer

INDUSTRIAL



Flojet Pump

1/4" AODD
Santoprene Diaphragm
Viton Diaphragm

LAFFERTY AIR PUMP ASPHALT RELEASE SPRAYERS are powered by a double diaphragm air pump and are designed for use in facilities where plumbed water is unavailable or where water pressure is too low or unreliable. Three of these systems accurately dilute chemical concentrates to the required ratios and project an even spray onto the beds of asphalt trucks or other surfaces. The fourth uses ready-to-use chemical solution.

The unique Lafferty Metering Manifold allows fine adjustment of flow for both water and asphalt release agent, providing for virtually any desired dilution ratio.

Air Pump Asphalt Release Sprayers are offered as either manual or timed models.

AIR PUMP ASPHALT RELEASE SPRAYERS

AP Asphalt Release Sprayer (Metering Manifold) 931108FPS

REQUIRES: COMPRESSED AIR, CHEMICAL CONCENTRATE AND A WATER SOURCE

- Draws water from a user-supplied static tank and asphalt release agent directly from original shipping containers.
- Unique metering manifold allows virtually any desired dilution ratio.

2-Way AP Asphalt Release Sprayer (Metering Manifold) 931112FT

REQUIRES: COMPRESSED AIR, CHEMICAL CONCENTRATE AND RUNNING WATER (MINIMAL PRESSURE)

- The air operated pump draws water from the integral float tank and asphalt release agent from original shipping containers
- Float tank is refilled automatically with minimal water pressure
- Unique 2-way metering manifold allows virtually any desired ratio of one or two chemicals
- Will apply two different asphalt release agents or two different ratios of the same agent.

Timed, AP Asphalt Release Sprayer (Pre-Dilute) 974321-TD

REQUIRES: ELECTRICITY, COMPRESSED AIR AND READY-TO-USE (RTU) CHEMICAL SOLUTION

- Precisely controls chemical use — An adjustable run timer controls the duration of application. An adjustable delay timer keeps the driver from immediately restarting the system, preventing costly over-application.
- Draws and sprays chemical solution from a user-supplied static tank

Timed, AP Asphalt Release Sprayer (Metering Manifold) 974323-TD

REQUIRES: ELECTRICITY, COMPRESSED AIR, CHEMICAL CONCENTRATE AND A WATER SOURCE

- Precisely controls chemical use — An adjustable run timer controls the duration of application. An adjustable delay timer keeps the driver from immediately restarting the system, preventing costly over-application.
- Draws water from a user-supplied static tank and asphalt release agent directly from original shipping containers
- Unique metering manifold allows virtually any desired dilution ratio



Model #	Description
931108FPS	FPS-MM Asphalt Release Sprayer
931112FT	2-Way FPS-MM-FT Asphalt Release Sprayer
974321-TD	Timed AP PD Asphalt Release Sprayer
974323-TD	Timed FPV-MM Asphalt Release Sprayer
Optional:	
720976	Retrofit Heater Assembly — 4" x 10 1/2"



Optional: #536500 Insulator for 1/4" SS Wand Aids gripping and insulates against hot and cold extremes of the metal wand.

REQUIREMENTS / SPECIFICATIONS

Compressed Air	up to	4 cfm	113.3 lpm
Spray Volume	up to	2.0 gpm	7.6 lpm
Discharge Hose			
ID		1/2 in.	12.7 mm
Length		25 ft.	7.6 m
Electricity (Timed Models)		120VAC	

Includes

- Lockable, stainless steel enclosure
- Santoprene diaphragm air pump (Viton diaphragm for 974323-TD)
- Machined polypropylene Metering Manifold
- Discharge hose assembly with stainless steel ball valve, wand and nozzle

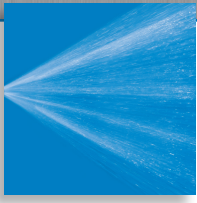

Electric Pump

Santoprene Diaphragm

LAFFERTY ELECTRIC PUMP ASPHALT RELEASE SPRAYERS are powered by an electric pump and are designed for use in facilities where plumbed water is unavailable or where water pressure is too low or unreliable. These systems accurately dilute chemical concentrates to the required ratios and project an even spray onto the beds of asphalt trucks or other surfaces.

Electric Pump Asphalt Release Sprayers are offered as either manual or timed models.

ELECTRIC PUMP ASPHALT RELEASE SPRAYERS

Electric Pump Asphalt Release Sprayer

REQUIRES: ELECTRICITY, CHEMICAL CONCENTRATE AND WATER SOURCE

- Draws water from a user-supplied static tank and asphalt release agent directly from original shipping containers, accurately diluting it to the required ratio.
- No chemical passes through the electric pump

Timed, Electric Pump Asphalt Release Sprayer

REQUIRES: ELECTRICITY, CHEMICAL CONCENTRATE AND RUNNING WATER

- Precisely controls chemical use — An adjustable run timer controls the duration of application. An adjustable delay timer keeps the driver from immediately restarting the system, preventing costly over-application.
- Draws water from an integral float tank and asphalt release agent directly from original shipping containers, accurately diluting it to the required ratio.
- Float tank is refilled automatically with minimal water pressure.
- No chemical passes through the electric pump

REQUIREMENTS / SPECIFICATIONS

Electric		120V	
Spray Volume	up to	2.0 gpm	7.6 lpm
Discharge Hose			
ID		1/2 in.	12.7 mm
Length		25 ft.	7.6 m

Includes

- Lockable, stainless steel enclosure
- Electric pump
- Machined polypropylene injector body
- Color-coded metering tips (20)
- Metering tip driver
- Discharge hose assembly with stainless steel ball valve, wand and nozzle



Model #	Description
974212	Electric W-25 Asphalt Release Sprayer
974212-TD	Timed FT Electric W-25 Asphalt Release Sprayer
Optional:	
720976	Retrofit Heater Assembly — 4"x10 1/2"



Optional: #536500 Insulator for 1/4" SS Wand
Aids gripping and insulates against hot and cold extremes of the metal wand.



INDUSTRIAL



LAFFERTY DART™ SPRAY SYSTEMS AND FOAM SYSTEMS are powered

by a double diaphragm air pump or an electric stainless steel pump and equipped with remote push button activation. The amount of chemical dispensed per truck is timer controlled, preventing over application.

DART™ Systems provide safe, reliable and controlled application of asphalt release agents to truck beds. The driver remains in his cab, avoiding the risk of slip-and-fall injury or chemical exposure. Choice of models to suit application requirements.

DRIVE-THRU AIR SPRAY SYSTEMS AND FOAM SYSTEMS – Push Button Activated

REQUIRES: COMPRESSED AIR, ELECTRICITY, RUNNING WATER AND CHEMICAL CONCENTRATE (AP SYSTEMS) / ELECTRICITY AND RTU CHEMICAL (EP SYSTEM)

- Systems are remote push button activated
- Adjustable delay activation timer allows the driver to position the truck bed under the spray nozzle or foam bar before application begins.
- Adjustable run timer controls the length of application time to prevent overuse of asphalt release agent
- Air operated pump delivers the solution through a specially designed spray nozzle or foam bar assembly that evenly coats the truck bed in just seconds, reducing run-off and waste.

Choice of two spray models

977801

- Air operated pump draws water from a user-supplied static tank and asphalt release agent from original shipping containers. Float valve included to allow water tank to auto refill if connected to a water supply line
- Unique metering manifold allows virtually any desired dilution ratio

977881 - Sprays RTU chemical solution

Foam model

977901

- Air operated pump draws water from a user-supplied static tank and asphalt release agent from original shipping containers. Float valve included to allow water tank to auto refill if connected to a water supply line
- Unique metering manifold allows virtually any desired dilution ratio

REQUIREMENTS / SPECIFICATIONS

Electricity 120V

Compressed Air

Spray	up to	10 cfm	283.2 lpm\
Foam	up to	16 cfm	453.1 lpm

Includes

- Lockable, stainless steel enclosure
- Dual function timer with delay and run time settings
- Air pump with Santoprene diaphragms (AP-MM models)
- Float valve assembly for water tank (AP-MM models)
- 110V electric, stainless steel pump (977881)

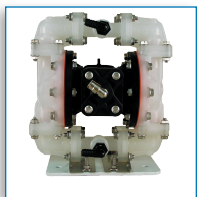

Sandpiper Pump

1/2" AODD
Santoprene Diaphragm



Electric Pump

110V, 1 HP
Stainless Steel

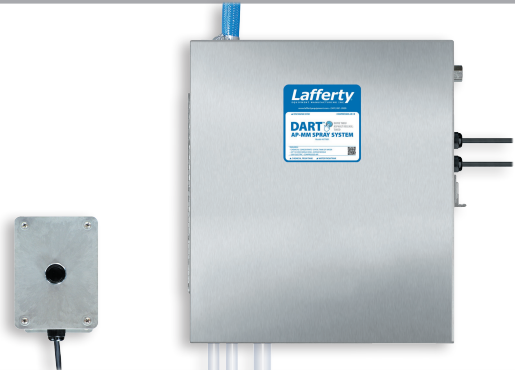

Model #	Description
977801	DART™ AP-MM Spray System
977881	DART™ EP-PD Spray System
977901	DART™ AP-MM Foam System
Optional	
720981	Retrofit Heater Assembly, 7" x 18 1/2"

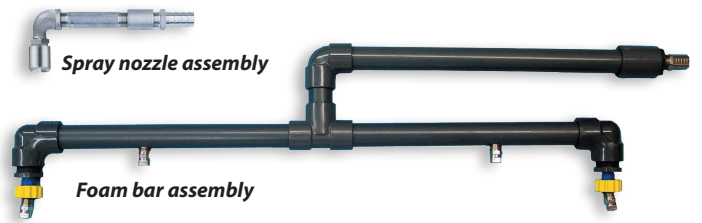



LAFFERTY RADAR™ AP-MM SPRAY AND FOAM SYSTEMS are powered

by a double diaphragm air pump and include sensors that detect the presence of a truck and automatically activate the system. The default sensor set up is a pair of "electric eyes" (photocell sensors). Other available sensors, as denoted in the model descriptions, are *Single Eye* photocell sensor and *Magnetic* sensor. (Further details listed below.) The system stops and resets at the end of a pre-set time period or when the vehicle leaves the sensor area.

RADAR™ Systems provide safe, reliable and controlled application of asphalt release agents to truck beds. The driver remains in his cab, avoiding the risk of slip-and-fall injury or chemical exposure. Choice of models to suit application requirements.

RAPID DRIVE-THRU AR SPRAY SYSTEMS AND FOAM SYSTEMS – Sensor Activated

REQUIRES: COMPRESSED AIR, ELECTRICITY, RUNNING WATER, CHEMICAL CONCENTRATE

- Systems automatically activate and deliver asphalt release agent through a specially designed spray nozzle or foam bar assembly that evenly coats the truck bed in just seconds, then shut off automatically.

Activation methods (depending on model selected)

- **RADAR System:** The system starts when the truck breaks the powerful, wide beam between the two electric eyes (photocells).
- **RADAR Single Eye System:** The system starts when the truck disrupts the sensor's field of view.
- **RADAR Magnetic System:** The system starts when the adjustable sensitivity sensor detects the truck's metal components.

All Systems Feature

- **Adjustable delay activation timer** – Allows the driver to position the truck bed under the spray nozzle or foam bar assembly before application begins
- **Adjustable run timer** – Controls the length of application time to prevent overuse of asphalt release agent
- **Air operated pump** – Operates where plumbed water pressure is unavailable or unreliable. Float valve is included to allow water tank to auto fill, if connected to a water supply line.
- **Metering Manifold (MM)** – The unique metering manifold allows virtually any desired dilution ratio as the pump draws water and concentrated asphalt release agent through separate tubes and mixes them to the required ratio on the fly.*
- **Alternative Pre-Dilute / RTU Chemical set up** – Place all three chemical/ water tubes in the chemical tank to draw and pressurize a ready-to-use (RTU / pre-diluted) chemical solution only

REQUIREMENTS / SPECIFICATIONS

Electricity	120V		
Compressed Air			
Spray	up to	10 cfm	283.2 lpm
Foam	up to	16 cfm	453.1 lpm

Includes

- Lockable, stainless steel enclosure
- Multifunction timer with delay and run timers
- Air pump with Santoprene diaphragms
- Float valve assembly for water tank (MM models)
- Discharge hose with either spray nozzle assembly or foam bar assembly

RADAR Systems (illustrated at right) – The system starts when the truck breaks the beam between the two electric eyes (photocells).

RADAR Single Eye System – The system starts when the truck disrupts the sensor's field of view.

RADAR Magnetic System – The system starts when the adjustable sensitivity sensor detects the truck's metal.

Lafferty's unique Metering Manifold controls chemical and water dilution ratio.

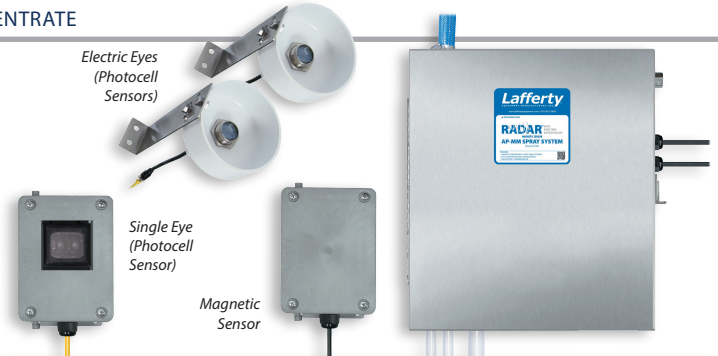

Model #	Description
977840	RADAR™ Single Eye AP-MM Spray System
977841	RADAR™ AP-MM Spray System
977845	RADAR™ Magnetic AP-MM Spray System
977930	RADAR™ AP-MM Foam System

Optional	Description
720981	Retrofit Heater Assembly, 7" x 18 1/2"

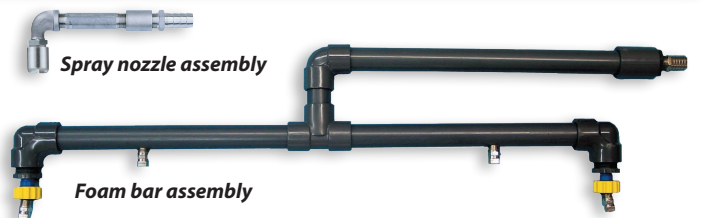

INDUSTRIAL



LAFFERTY RADAR™ EP SPRAY SYSTEMS are powered by an electric stainless steel pump and include electric eye (photocell) sensors that detect the presence of a truck and automatically activate the system. (Further details listed below.) The system stops and resets at the end of a pre-set time period or when the vehicle leaves the sensor area.

EP-LM systems include a companion Level Master™ that automatically maintains the desired level of ready-to-use (RTU) chemical solution. The EP-PD System draws ready-to-use chemical solution directly from a user-supplied tank.

RAPID DRIVE-THRU ELECTRIC PUMP AR SPRAY SYSTEMS – Sensor Activated

REQUIRES: ELECTRICITY AND CHEMICAL CONCENTRATE WITH 25 - 100 PSI WATER OR A WATER SOURCE; OR RTU CHEMICAL (MODEL #977887)

Systems automatically activate and deliver asphalt release agent through a specially designed spray nozzle or foam bar assembly that evenly coats the truck bed in just seconds, then shut off automatically.

Activation methods (depending on model selected)

- **RADAR System:** The system starts when the truck breaks the powerful, wide beam between the two electric eyes (photocells).
- **RADAR Single Eye System:** The system starts when the truck disrupts the sensor's field of view.

All Systems Feature

- **Adjustable delay activation timer** – Allows the driver to position the truck bed under the spray nozzle before application begins
- **Adjustable run timer** – Controls the length of application time to prevent overuse of asphalt release agent
- **Stainless steel electric pump** – Delivers the solution through a specially designed spray nozzle that evenly coats the truck bed in just seconds, reducing run-off and waste.

Model-Specific Features

- **EP-LM** — Includes a 7 Gallon Lafferty Level Master™, which dilutes concentrated asphalt release agents to the desired ratio and maintains a supply of RTU chemical solution. (Requires water pressure of 25-100 PSI.)
- 977892 – **Enclosed Level Master™ and Heaters** included. Both the Level Master and the electric pump are contained in heated stainless steel enclosures
- 977887 **EP-PD** — RTU chemical solution required in user-supplied tank

REQUIREMENTS / SPECIFICATIONS

Electricity 120V
Water Pressure (Except 977887) 25 - 100 PSI 1.7 - 6.9 bar

Includes

- Lockable, stainless steel enclosure (two with 977892)
- Dual function timer with delay and run time settings
- Stainless steel electric pump
- 7 Gallon Level Master (Except 977887)

The Lafferty 7 Gallon Level Master™ is included with RADAR™ EP-LM Spray Systems.

Level Master™ Systems are float valve operated proportioners that automatically maintain the desired level of ready-to-use (RTU) chemical solution



Model #	Description
977887	RADAR™ EP-PD Spray System
977889	RADAR™ Single Eye EP-LM Spray System
977890	RADAR™ EP-LM Spray System
977892	RADAR™ EP-LM Spray System with Enclosed 7 Gallon Level Master™ and Heaters

Optional Retrofit Heater

720981	Retrofit Heater Assembly, 7" x 18 1/2"
--------	--



Acid / Corrosive Applications



LAFFERTY ACID MIXING STATIONS are designed for use with strongly corrosive chemicals, such as those used in the concrete industry and for aluminum brightening. For use where the bucket-and-brush method of concrete removal or cleaning is used, these water-driven venturi systems accurately dilute chemical concentrates to the required ratios and fill any size container with ready-to-use (RTU) chemical solution.

Lafferty Mixing Stations eliminate the need for manual mixing, optimizing chemical utilization, employee safety and labor utilization.

Choice of 2 flow rates – both capable of achieving a true 1:1 dilution ratio.

HIGH CONCENTRATE ACID MIXING STATIONS

REQUIRES: 40-80 PSI WATER, CHEMICAL CONCENTRATE

- Lafferty High Concentrate Acid Mixing Stations will deliver a true 1:1 dilution ratio with water thin chemical. (Included metering plugs provide 2:1 and 3:1 ratios.) Chemical viscosity will affect dilution ratios.
- Draw concentrate directly from original shipping containers and accurately dilute it to the required ratio
- Choice of two flow rates
- 2-Way model is for use with either two different compatible chemicals or for three different ratios of the same chemical

REQUIREMENTS / SPECIFICATIONS

Water Pressure	40 - 80 PSI	2.4 - 5.5 bar
Water Flow Rate	@ 40 PSI	@ 2.8 bar
105HC	up to 1½ gpm	5.7 lpm
207HC	up to 2 gpm	7.6 lpm
Discharge Hose		
ID	1/2 in.	12.7 mm
Length	10 ft.	3.0 m

Includes

- Machined polypropylene injector body
- Polypropylene mounting plate and cover
- Metering plugs for 2:1 and 3:1 ratios
- Color coded metering tips for up to 21 dilution ratios
- Metering tip driver
- Discharge hose

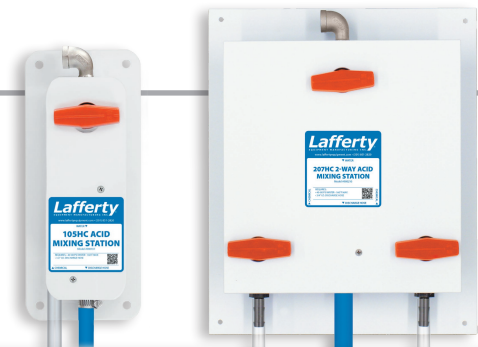

Model #	Description
980107	105HC Acid Mixing Station
980208	207HC Acid Mixing Station
980210	207HC 2-Way Acid Mixing Station

INDUSTRIAL

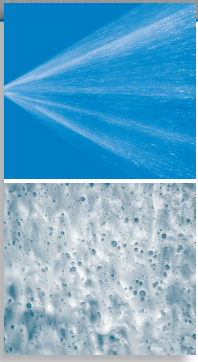

LAFFERTY ACID SPRAYERS AND AIRLESS FOAMERS are designed for use with strongly corrosive chemicals, such as those used in the concrete industry and for aluminum brightening. They are water-driven venturi systems that accurately dilute chemical concentrates to the required ratios and project an even spray, or airless foam, onto any surface.

Choice of 1-Way, 2-Way and 3-Way models – all capable of achieving strong chemical ratios.

The 2-Way Acid Airless Foam/Rinse System is a convenient combination applicator that will apply concrete remover and neutralizer as an airless foam and then rinse through a separate hose.

ACID SPRAY-ALLS AND AIRLESS FOAMERS

REQUIRES: 35-125 PSI WATER, CHEMICAL CONCENTRATE

- Draw concentrate directly from original shipping containers and accurately dilute it to the required ratio
- Choice of 1-Way, 2-Way and 3-Way models
- LV model offers a lower flow rate.

Acid Spray-Alls

- Project an even spray pattern for quick coverage

Acid Airless Foamers

- For acids that foam — Project an even foam pattern for quick coverage
- Foam provides visual confirmation of coverage

Drum Bung Mount Model

- Mount directly to drum

REQUIREMENTS / SPECIFICATIONS

Water Pressure	35 - 125 PSI	2.4 - 8.6 bar
Water Flow Rate	@ 40 PSI	@ 2.8 bar
All but LV model	up to 2.0 gpm	7.6 lpm
LV	up to 1.0 gpm	3.8 lpm
Discharge Hose		
ID	1/2 in.	12.7 mm
Length	50 ft.	15.2 m

Includes

- Machined polypropylene injector body
- Color-coded metering tips (20)
- Metering tip driver
- Discharge hose assembly with PVC ball valve and nozzle or airless foam wand

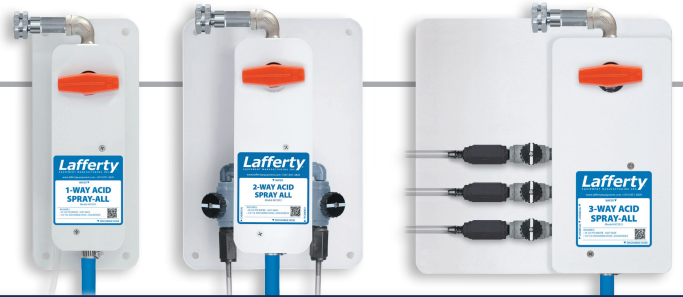

Model #	Description
972011	1-Way Acid Spray-All
972011-LV	1-Way Acid W-20HC Spray-All
972012	2-Way Acid Spray-All
972013	3-Way Acid Spray-All



Model #	Description
972211	1-Way Acid Airless Foamer
972212	2-Way Acid Airless Foamer
972213	3-Way Acid Airless Foamer



Model #	Description
972225	Drum Bung Mount Acid Airless Foamer

AIR ASSISTED

LAFFERTY ACID FOAMERS are designed for use with strongly corrosive chemicals, such as those used in the concrete industry and for aluminum brightening. They are water-driven, air-assisted venturi systems that accurately dilute chemical concentrates to the required ratios and project high quality foam onto any surface.

Choice of 1-Way, 2-Way and 3-Way models and three flow rates – all capable of achieving strong chemical ratios.

ACID LV FOAMERS

REQUIRES: 40-125 PSI WATER, COMPRESSED AIR, CHEMICAL CONCENTRATE

- Low Volume output for precise foaming applications
- Draw concentrate directly from original shipping containers and accurately dilute it to the required ratio
- Covers up to 500 ft.² (46.5 m²) in 4 ½ minutes
- Usable foam throw distance of up to 9 feet
- Choice of 1-Way, 2-Way and 3-Way models

REQUIREMENTS / SPECIFICATIONS

Compressed Air	2.5 - 6 cfm	70.8 - 169.9 lpm
Water Pressure	40 - 125 PSI	2.6 - 8.6 bar
Water Flow Rate	@ 40 PSI	@ 2.6 bar
	0.65 gpm	2.4 lpm
Discharge Hose		
ID	3/4 in.	19.1 mm
Length	40 ft.	12.2 m

Includes

- Machined polypropylene foamer body
- Polypropylene mounting plate and cover
- Color-coded metering tips (20) and metering tip driver
- Discharge hose assembly with PVC ball valve, extended wand and fan nozzle

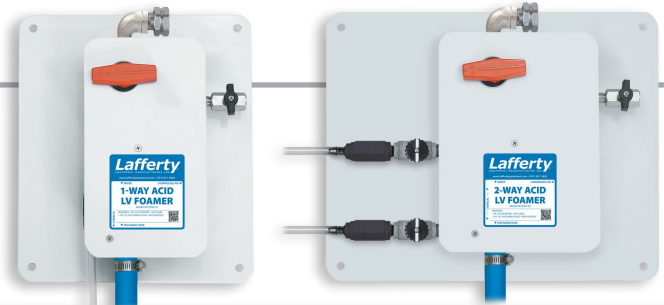

Model #	Description
972306-LV	1-Way Acid LV Foamer
972307-LV	2-Way Acid LV Foamer
972308-LV	3-Way Acid LV Foamer



ACID LC FOAMERS

REQUIRES: 40-125 PSI WATER, COMPRESSED AIR, CHEMICAL CONCENTRATE

- Medium Volume output for all foaming applications
- Draw concentrate directly from original shipping containers and accurately dilute it to the required ratio
- Covers up to 500 ft.² (46.5 m²) in 2 minutes
- Usable foam throw distance of up to 12 feet
- Choice of 1-Way, 2-Way and 3-Way models

REQUIREMENTS / SPECIFICATIONS

Compressed Air	2.5 - 6 cfm	70.8 - 169.9 lpm
Water Pressure	40 - 125 PSI	2.6 - 8.6 bar
Water Flow Rate	@ 40 PSI	@ 2.6 bar
	1.3 gpm	4.9 lpm
Discharge Hose		
ID	3/4 in.	19.1 mm
Length	40 ft.	12.2 m

Includes

- Machined polypropylene foamer body
- Polypropylene mounting plate and cover
- Color-coded metering tips (20) and metering tip driver
- Discharge hose assembly with PVC ball valve, extended wand and fan nozzle

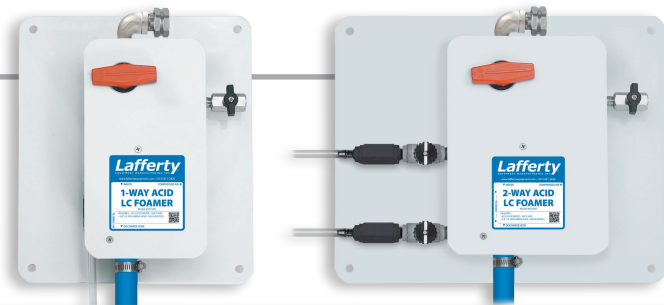

Model #	Description
972306	1-Way Acid LC Foamer
972307	2-Way Acid LC Foamer
972308	3-Way Acid LC Foamer



INDUSTRIAL

ACID HV FOAMER

REQUIRES: 40-125 PSI WATER, COMPRESSED AIR, CHEMICAL CONCENTRATE

- High volume output
- Draw concentrate directly from original shipping containers and accurately dilute it to the required ratio
- Covers up to 500 ft.² (46.5 m²) in 1 minute
- Usable foam throw distance of up to 15 feet
- Choice of 1-Way, 2-Way and 3-Way models

REQUIREMENTS / SPECIFICATIONS

Compressed Air	4 - 16 cfm	113.3 - 453.1 lpm
Water Pressure	50 - 125 PSI	3.4 - 8.6 bar
Water Flow Rate	@ 40 PSI	@ 3.4 bar
	4.0 gpm	15.1 lpm
Discharge Hose		
ID	1 in.	25.4 mm
Length	50 ft.	15.2 m

Includes

- Machined polypropylene foamer body
- Polypropylene mounting plate and cover
- Color-coded metering tips (20)
- Metering tip driver
- Discharge hose assembly with PVC ball valve, extended wand and fan nozzle

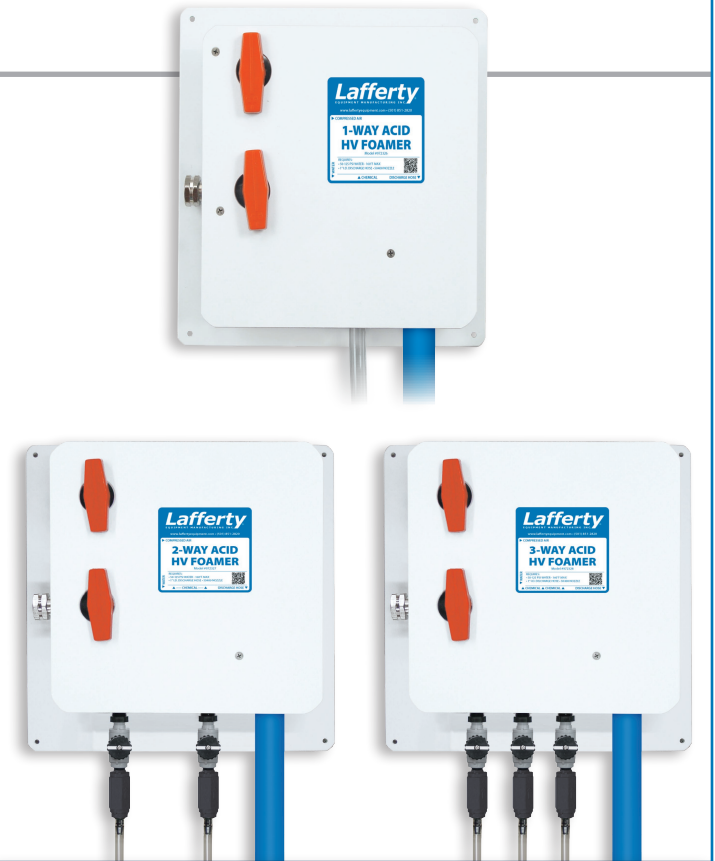

Model #	Description
972326	1-Way Acid HV Foamer
972327	2-Way Acid HV Foamer
972328	3-Way Acid HV Foamer



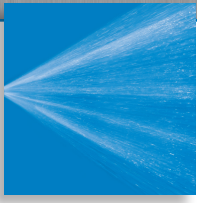

Flojet Pump

1/4" AODD
Viton Diaphragm

LAFFERTY APV AIR PUMP ACID SPRAYERS are powered by a Flojet double diaphragm air pump and designed for use with strongly corrosive chemicals, such as those used in the concrete industry and for aluminum brightening. Intended for achieving strong chemical concentrations in facilities where plumbed water is unavailable, or where water pressure is too low or unreliable.

Optimized flow volume produces the ideal amount of spray, avoiding excessive chemical run-off and overspray, and minimizing neutralizer requirements.

Offered with durable, corrosion resistant plastic mounting enclosures, with a choice of models to suit application requirements.

APV AIR PUMP ACID SPRAYERS

Air Pump Acid Sprayer (Pre-Dilute)

REQUIRES: COMPRESSED AIR, READY-TO-USE CHEMICAL SOLUTION

- Sprays RTU chemical solution.

2-Way Air Pump Acid Sprayers (Metering Manifold)

REQUIRES: COMPRESSED AIR, WATER (MINIMAL PRESSURE) AND CHEMICAL CONCENTRATE

- Unique 2-way metering manifold allows virtually any desired ratio of one or two chemicals.
- Will apply two different chemicals or two different ratios of the same chemical
- Draws chemical from any container and water from a user-supplied static tank.

REQUIREMENTS / SPECIFICATIONS

Compressed Air	(up to)	4 cfm	113.3 lpm
Spray Volume		@ 60 PSI	@ 4.1 bar
		1.5 gpm	5.7 lpm
Discharge Hose			
ID		1/2 in.	12.7 mm
Length		50 ft.	15.2 m

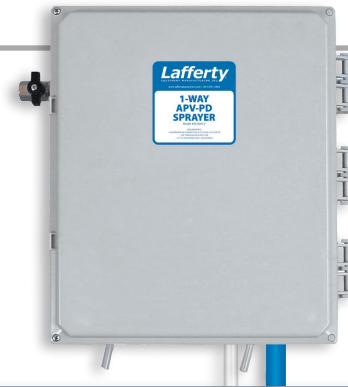

Model #	Description
932600-V	APV PD Concrete Sprayer
932607-V	2-Way APV MM Concrete Sprayer

Includes

- Chemical resistant plastic enclosure
- Air operated pump with Viton diaphragms
- Discharge hose assembly with PVC ball valve, extended wand and matching nozzle.



INDUSTRIAL

CONTROLLERS FOR AIR PUMP ACID SPRAYERS AND FOAMERS

- A timed controller can be added to any Air Pump Acid Sprayer or Foamer to provide precise control of chemical use.
- Choice of two timer models:

TIMED WITH REMOTE PUSH BUTTON

- An adjustable run timer controls the length of application.
- An adjustable delay timer keeps the driver from immediately restarting the system, preventing costly over-application.

COIN OPERATED

- Electronic coin acceptor activates an adjustable timer that controls the length of application.
- Coin acceptor is built to withstand dirty, moist and unforgiving environments.
- 100 tokens included.





Yamada Pump

1/4" AODD
Teflon Diaphragm

Flojet Pump

1/4" AODD
Viton Diaphragm

LAFFERTY PRE-DILUTE AIR PUMP ACID FOAMERS are air-pump-powered and are designed for use with strongly corrosive chemicals, such as those used in the concrete industry and for aluminum brightening.

Intended for use in facilities where pre-dilution of chemical is preferred, or where plumbed water is unavailable or the pressure unreliable.

Optimized flow volume produces the ideal amount of foam, avoiding excessive chemical run-off and overspray, and minimizing neutralizer requirements.

Offered with durable, corrosion resistant plastic mounting enclosure. Choice of 1-Way or 2-Way models

AIR PUMP ACID FOAMERS (Pre-Dilute) - Yamada

REQUIRES: COMPRESSED AIR, READY-TO-USE CHEMICAL SOLUTION

- Powered by a Yamada air pump with Teflon diaphragms
- Draw RTU chemical solution and project high quality foam onto any surface
- 2-Way model is for use with either 2 different compatible chemical solutions, or 2 different concentrations of the same chemical

REQUIREMENTS / SPECIFICATIONS

Air Pressure	up to	4 cfm	113.3 lpm
Discharge Hose			
ID		3/4 in.	19.1 mm
Length		50 ft.	15.2 m

Includes

- Chemical resistant plastic enclosure
- Air operated pump with Teflon diaphragms
- Discharge hose assembly with PVC ball valve, extended wand and fan nozzle



Model #	Description
933505-YPT	1-Way YPT-PD Concrete Foamer
933507-YPT	2-Way YPT-PD Concrete Foamer



AIR PUMP ACID FOAMER (Pre-Dilute) - Flojet

REQUIRES: COMPRESSED AIR, READY-TO-USE CHEMICAL SOLUTION

- Powered by a Flojet air pump with Viton diaphragms
- Draws RTU chemical solution and projects high quality foam onto any surface
- 2-Way model is for use with either 2 different compatible chemical solutions, or 2 different concentrations of the same chemical
- 2-Way PD/MM model (933625-V) draws either ready-to-use chemical solution or water and chemical concentrate through a unique metering manifold that adjusts chemical to water ratio from 1:1 to neat chemical.

REQUIREMENTS / SPECIFICATIONS

Air Pressure	up to	4 cfm	113.3 lpm
Discharge Hose			
ID		3/4 in.	19.1 mm
Length		50 ft.	15.2 m

Includes

- Chemical resistant plastic enclosure
- Air operated pump with Viton diaphragms
- Discharge hose assembly with PVC ball valve, extended wand and fan nozzle



Model #	Description
933602-V	1-Way FPV-PD Concrete Foamer
933604-V	2-Way APV-PD Concrete Foamer
933625-V	2-Way FPV-PD/MM Concrete Foamer





Flojet Pump

1/4" AODD
Viton Diaphragm

LAFFERTY SPECIALTY APV AIR PUMP CONCRETE FOAMERS AND SPRAYERS are highly versatile chemical application systems, with a unique combination of features and capabilities. The systems can achieve a wide range of strong chemical dilution ratios, including the ability to apply straight chemical, and are used to project high quality foam or spray onto any surface.

Powered by Flojet double diaphragm air pumps with Viton diaphragms, these units are designed for use with strongly corrosive chemicals, such as those used in the concrete industry and for aluminum brightening. Intended for use in facilities where plumbed water pressure is available, but unreliable.

Optimized flow volume produces the ideal amount of foam or spray, avoiding excessive chemical run-off and overspray, and minimizing neutralizer requirements.

Offered with a durable, corrosion resistant plastic mounting enclosure with a choice of 1-Way, 2-Way and Dual Pump models to suit application requirements.

SPECIALTY APV AIR PUMP ACID FOAMERS

1-Way Air Pump Concrete Foamer (933405-V)

REQUIRES: COMPRESSED AIR, 20-125 PSI WATER, CHEMICAL CONCENTRATE

- Draws water from a user-supplied static tank and chemical concentrate directly from original shipping containers
- Unique metering manifold allows virtually any desired dilution ratio

2-Way Air Pump Acid Foamer (933417-V and 933417-V-TDR)

REQUIRES: COMPRESSED AIR, 20-125 PSI WATER, CHEMICAL CONCENTRATE

- 2-Way model is for use with either 2 different compatible chemicals, or 2 different concentrations of the same chemical
- Draws chemical concentrates from any containers
- Dilution ratios are easily controlled from 11:1 up to 1:1 (Stronger solutions are achievable – up to applying straight chemical)
- The time delay model (933417-V-TDR) precisely controls chemical use—an adjustable run timer controls the duration of application. An adjustable delay timer keeps the driver from immediately restarting the system, preventing costly over application.

1-Way Air Pump Concrete Foamer (Metering Manifold) (933605-V)

REQUIRES: COMPRESSED AIR, WATER TANK, CHEMICAL CONCENTRATE

- Draws water from a user-supplied static tank and chemical concentrate directly from original shipping containers
- Unique metering manifold allows virtually any desired dilution ratio

Dual Pump Concrete Sprayer / Foamer (Pre-Dilute) (933712-V)

REQUIRES: COMPRESSED AIR, READY-TO-USE CHEMICAL SOLUTIONS

- This model is for use with 2 different chemicals, with one to be applied as foam and the other as spray
- Draws RTU chemical solution from any container

REQUIREMENTS / SPECIFICATIONS

Compressed Air	(up to)	4 cfm	113.3 lpm	Includes
Discharge Hose				<ul style="list-style-type: none"> • Chemical resistant plastic enclosure • Machined polypropylene foamer/sprayer bodies (933405-V and 933712-V) • Machined polypropylene metering manifold and foamer body (933417-V) • Air operated pump with Viton diaphragms (2 with 933712-V) • Discharge hose assembly with PVC ball valve, extended wand and nozzle (two with 933712-V)
ID				
Sprayer		1/2 in.	12.7 mm	
Foamer		3/4 in.	19.1 mm	
Length		50 ft.	15.2 m	



Model #	Description
933405-V	1-Way APV PFPR Concrete Foamer
933417-V	2-Way APV MMPR Concrete Foamer
933417-V-TDR	Timed delay 2-Way APV MMPR
933605-V	1-Way APV-MM Concrete Foamer
933712-V	Dual Pump FPV-PD Concrete Sprayer/Foamer



INDUSTRIAL

Solvent Application



LAFFERTY SOLVENT MIXING STATIONS™ are water-driven venturi proportioners that accurately dilute concentrated solvents to required ratios and fill any size container with diluted, ready-to-use (RTU) solvent solution. Choice of two flow rates.

These proportioners are suitable for diluting many higher-flash-point solvents, including d-limonene.

SOLVENT MIXING STATIONS

REQUIRES: 35-100 PSI WATER

- Draw concentrate directly from original shipping containers and accurately dilute it to the required ratio

REQUIREMENTS / SPECIFICATIONS

Water Pressure	35 - 100 PSI	2.4 - 6.9 bar
Water Flow Rate	@ 40 PSI	@ 2.8 bar
Low Flow	2.0 gpm	7.6 lpm
High Flow	4.0 gpm	15.1 lpm

Includes

- Stainless steel mounting enclosure
- Integrated hose connection vacuum breaker
- Machined stainless steel injector body
- Color-coded metering tips (20)
- Metering tip driver
- Solvent resistant pick-up and discharge tubes



Model #	Description
985100SS*	1-Way Ball Valve SS Mixing Station
985200SS*	2-Way Ball Valve SS Mixing Station

*Specify flow rate — HF (high flow) or LF (low flow)— at time of order

Certified to ASSE Standard 1055 for backflow prevention

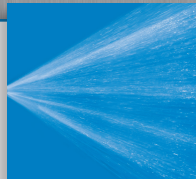

LAFFERTY SOLVENT SPRAYERS are water-driven venturi systems that accurately dilute concentrated solvents to required ratios and project a medium spray onto any surface.

These systems are suitable for diluting and spraying many higher-flash-point solvents, including d-limonene.

SOLVENT SPRAY-ALLS™

REQUIRES: 35-125 PSI WATER

- Lafferty Solvent Spray-Alls accurately dilute chemical concentrates and produce a medium spray.
- Fan nozzle for quick area coverage

REQUIREMENTS / SPECIFICATIONS

Water Pressure	35 - 125 PSI	2.4 - 8.6 bar
Water Flow Rate	@ 40 PSI	@ 2.8 bar
W-20 – Medium Spray	0.6 gpm	2.3 lpm
Discharge Hose		
ID	1/2 in.	12.7 mm
Length	50 ft.	15.2 m

Includes

- Machined stainless steel injector body
- Stainless steel mounting enclosure
- Color-coded metering tips (20)
- Metering tip driver
- Discharge hose, stainless steel ball valve, stainless steel wand and matching fan nozzle



Model #	Description
970220HC-D	W-20SSHC Solvent Spray-All

*HC (High Concentrate)



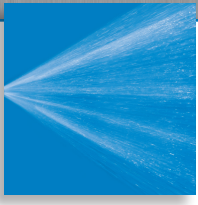

Warren Rupp

3/8" AODD
Kynar Pump
Teflon Diaphragm

LAFFERTY AIR PUMP SOLVENT SPRAYERS are powered by a double diaphragm air pump and are designed for use in facilities where plumbed water is unavailable or where water pressure is too low or unreliable. These systems produce and project an even spray onto any surface.

These sprayers are suitable for handling many higher-flash-point solvents, including d-limonene.

Choice of two models to suit application requirements.

AIR PUMP SOLVENT SPRAYERS

Air Pump MT Solvent Sprayer (Metering Tip)

REQUIRES: COMPRESSED AIR, CHEMICAL CONCENTRATE, WATER SOURCE

- Draws water from a user-supplied static tank and concentrated solvent from original shipping containers, accurately diluting it to the required ratio.
- Color-coded metering tips (20)

Air Pump PD Solvent Sprayer (Pre-Dilute)

REQUIRES: COMPRESSED AIR, RTU CHEMICAL SOLUTION

- Sprays RTU or neat solvent solution

REQUIREMENTS / SPECIFICATIONS

Compressed Air	(up to)	4 cfm	113.3 lpm
Spray Volume	@ 60 PSI		@ 4.1 bar
		2.0 gpm	7.6 lpm
Discharge Hose			
ID	1/2 in.		12.7 mm
Length	50 ft.		15.2 m

Includes

- Lockable stainless steel enclosure
- Kynar air pump with Teflon diaphragms
- Discharge hose assembly with trigger gun, stainless steel wand and fan nozzle



Model #	Description
930110	1-Way AP-MT Solvent Sprayer
930109	1-Way AP-PD Solvent Sprayer



INDUSTRIAL

CONTROLLERS FOR AIR PUMP ACID SPRAYERS AND FOAMERS

- A timed controller can be added to any Air Pump Acid Sprayer or Foamer to provide precise control of chemical use.
- Choice of two timer models:

TIMED WITH REMOTE PUSH BUTTON

- An adjustable run timer controls the length of application.
- An adjustable delay timer keeps the driver from immediately restarting the system, preventing costly over-application.

COIN OPERATED

- Electronic coin acceptor activates an adjustable timer that controls the length of application.
- Coin acceptor is built to withstand dirty, moist and unforgiving environments.
- 100 tokens included.



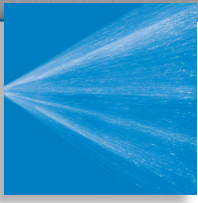

LAFFERTY INTERNAL TANK SOLVENT SPRAYERS are powered by compressed air. RTU solvent solution is held in an ASME rated stainless steel tank and compressed air is used to provide the required solution pressure for operation.

These systems are suitable for handling many higher-flash-point solvents, including d-limonene.

With no air pump or other moving parts, Internal Tank Sprayers are virtually maintenance-free, providing unrivalled durability.

SOLVENT TANK SPRAYER

REQUIRES: COMPRESSED AIR, READY-TO-USE CHEMICAL SOLUTION

- Project onto any surface a usable amount of solvent solution as an even, fan pattern spray
- Two fan nozzles included for controlling chemical usage
- Air pressure forces RTU solvent solution from the tank

REQUIREMENTS / SPECIFICATIONS

Compressed Air	(up to)	4 cfm	113.3 lpm
Spray Volume	@ 60 PSI	@ 4.1 bar	
2503 Nozzle		0.3 gpm	1.1 lpm
2506 Nozzle		0.7 gpm	2.6 lpm
Discharge Hose			
ID	1/2 in.		12.7 mm
Length			
5 Gal. and 16 Gal. models	25 ft.		7.6 m
37.4 Gal. model	50 ft.		15.2 m

Includes

- All stainless steel carts
- ASME rated stainless steel tank
- Stainless steel mounting enclosure
- Stainless steel relief pop-off valve
- Discharge hose assembly with stainless steel ball valve, wand and two spray nozzles

Optional Solvent Mixing Stations

- Lafferty Solvent Mixing Stations can be used to fill the tanks with RTU solvent solution



Model #	Sprayer Description	Spraying Time per Tank Fill (based on nozzle used)	Hose Length
925705-D	5 Gallon Tank Solvent Sprayer	7 or 15 minutes	25 ft / 7.6 m
925716-D	16 Gallon Tank Solvent Sprayer	22 or 47 minutes	25 ft / 7.6 m
925737-D	37.4 Gallon Tank Solvent Sprayer	51 or 110 minutes	50 ft / 15.2 m



FloJet Pump

1/4" AODD
ATEX Certified
Kalrez (FFKM)
Diaphragms

LAFFERTY SOLVENT / ALCOHOL CHEMICAL TRANSFER SYSTEMS use ATEX-certified compressed air-operated double diaphragm pumps to transfer flammable or potentially explosive liquids from bulk containers to any other container. Choice of models for handling from one to five products. Systems feature convenient trigger gun dispensing.

These are standard transfer systems upgraded three ways for applications requiring ATEX approval:

- ATEX-approved 1/4" AODD pump(s)
- Kalrez (FFKM) diaphragms
- EPDM discharge hose(s) and chemical pickup hose(s)

To order, select a standard Transfer System model and also order the ATEX upgrade.

SOLVENT / ALCOHOL CHEMICAL TRANSFER SYSTEMS

REQUIRES: COMPRESSED AIR OR CO₂ OR NITROGEN

- Pumps are designed and certified for use in potentially explosive atmospheres due to the fluids being handled.
- Non electric. Driven entirely by compressed air or a pressurized non-flammable gas such as CO₂ or N₂ (Nitrogen).
- Pump includes ground wire to prevent sparking from static electricity
- Quick, easy set up — All system components are mounted on a single, polypropylene mounting panel.
- Pump(s) held in place by a unique Lafferty quick-release, stainless steel bracket.
- Discharge hose stabilizer coupling protects pump discharge outlet from abuse due to excessive pulling on the hose.
- See Catalog 9 for our complete line of Chemical Management Systems

REQUIREMENTS:

Compressed Air/Gas up to 4 cfm
Flow Rate up to 4.5 gpm @ 60 PSI air

Includes

- Polypropylene mounting panel
- Air regulator and air gauge
- FloJet AODD pump with Kalrez diaphragms and Viton o-ring seals (ATEX approved)
- Stainless steel quick release bracket
- 15' EPDM chemical pickup tube and discharge hose
- Polypropylene trigger gun with stainless steel and EPDM internal components

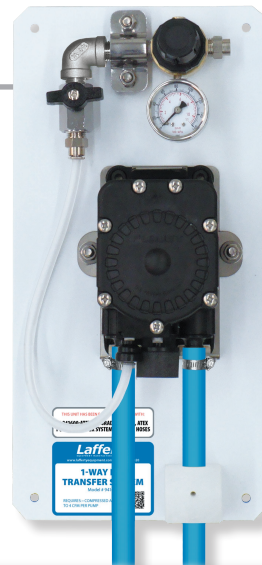

Model #	Description
941601	1-Way FPS Transfer System (Add ATEX upgrade x1)
941602	2-Way FPS Transfer System (Add ATEX upgrade x2)
941603	3-Way FPS Transfer System (Add ATEX upgrade x3)
941604	4-Way FPS Transfer System (Add ATEX upgrade x4)
941605	5-Way FPS Transfer System (Add ATEX upgrade x5)

SPECIFY ATEX UPGRADE:

941600-ATEX Upgrade chemical transfer system (per pump) with ATEX certified pump, 15' EPDM pickup hose, 15' EPDM discharge hose

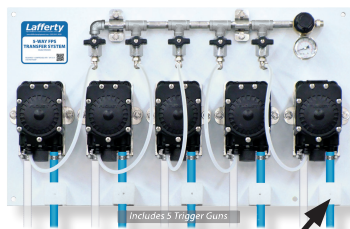

Discharge hose stabilizer coupling protects pump discharge outlet from abuse.



THIS UNIT HAS BEEN FACTORY MODIFIED WITH:
941600-ATEX • UPGRADE: KALREZ, ATEX PUMP (TRANSFER SYSTEMS) + EPDM HOSES

ACCESSORIES

In addition to supplying parts for all Lafferty equipment, Lafferty offers a range of convenient accessories to complement its wide range of chemical application equipment.

Stainless steel jug racks and hose racks can be used with many products, while Drum Sticks and Tote Sticks offer a convenient way to draw chemical from bulk containers. A water pressure / flow test kit provides guidance for equipment selection and when troubleshooting.

STAINLESS STEEL JUG RACKS

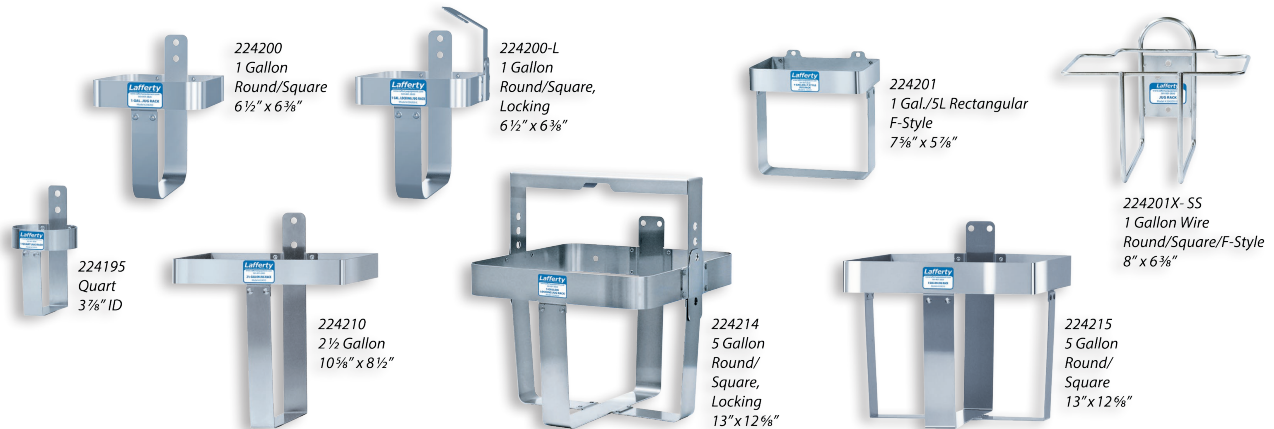

224200
1 Gallon
Round/Square
6 1/2" x 6 3/8"

224200-L
1 Gallon
Round/Square,
Locking
6 1/2" x 6 3/8"

224201
1 Gal./5L Rectangular
F-Style
7 5/8" x 5 7/8"

224201X-SS
1 Gallon Wire
Round/Square/F-Style
8" x 6 3/8"

224195
Quart
3 7/8" ID

224210
2 1/2 Gallon
10 5/8" x 8 1/2"

224214
5 Gallon
Round/
Square,
Locking
13" x 12 6/8"

224215
5 Gallon
Round/
Square
13" x 12 6/8"

DIMENSIONS

Model #		Diameter or Width x Depth	
224195	Quart	3 7/8 in. ID	9.8 cm ID
224200	1 Gal. Round/Sq.	6 1/2 x 6 3/8 in.	16.5 x 16.2 cm
224200-L	1 Gal. Rnd./Sq., Locking	6 1/2 x 6 3/8 in.	16.5 x 16.2 cm
224201	1 Gal./5L R'tangle, F-Style	7 5/8 x 5 7/8 in.	19.4 x 14.9 cm
224201X-SS	1 Gal. Wire, Rnd./Sq./F	8 x 6 3/8 in.	22.9 x 22.9 cm
224210	2 1/2 Gal.	10 5/8 x 8 1/2 in.	27.0 x 21.6 cm
224214	5 Gal. Rnd./Sq., Locking	13 x 12 6/8 in.	33.0 x 32.4 cm
224215	5 Gal. Rnd./Sq.	13 x 12 6/8 in.	33.0 x 32.4 cm

Model #	Description
224195	Jug Rack, SS, 1 Quart
224200	Jug Rack, SS, 1 Gallon Round/Square
224200-L	Jug Rack, SS, 1 Gallon Round/Square, Locking
224201	Jug Rack, SS, 1 Gallon/5 Litre Rectangular, F-Style
224201X-SS	Jug Rack, 1 Gallon SS Wire (Round/Square/F-Style)
224210	Jug Rack, SS, 2 1/2 Gallon
224214	Jug Rack, SS, 5 Gallon Round/Square, Locking
224215	Jug Rack, SS, 5 Gallon Round/Square

STAINLESS STEEL HOSE RACKS

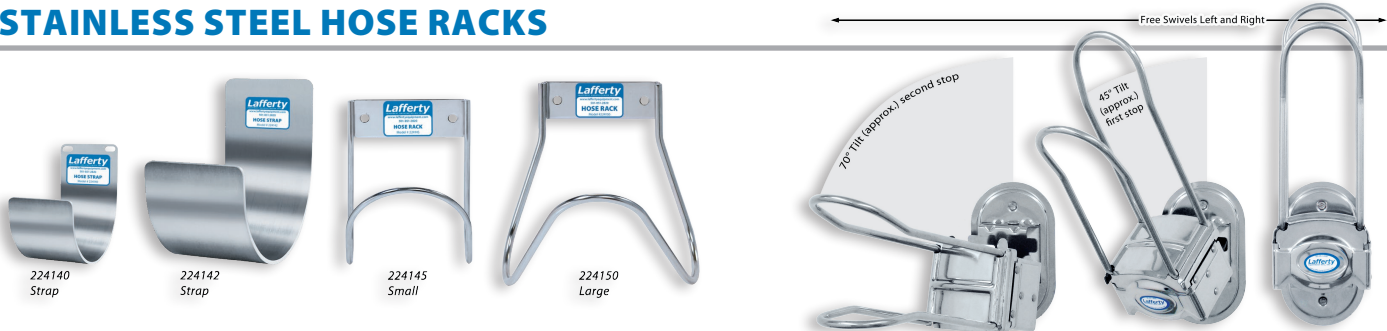

224140
Strap

224142
Strap

224145
Small

224150
Large

Free Swivels Left and Right
70° Tilt (approx.) second stop
45° Tilt (approx.) first stop

HOSE CARRYING CAPACITY

Model #		Inside Diameter x Length	
224140	Strap	1/2 in. ID up to 75 ft. (+/-)	12.7 mm ID x 22.9 m (+/-)
224142	Strap, L	3/4 in. ID up to 75 ft. (+/-)	19.1 mm ID x 22.9 m (+/-)
224145	Small	3/4 in. ID up to 50 ft. (+/-)	19.1 mm ID x 15.4 m (+/-)
224150	Large	1 in. ID up to 75 ft. (+/-)	25.4 mm x 22.9 m (+/-)
224160	Tilt	3/4 in. ID up to 100 ft. (+/-)	19.1 mm ID x 30.5+ m (+/-)

Model #	Description
224140	Hose Strap, SS
224142	Hose Strap, SS, Large
224145	Hose Rack, SS, Small
224150	Hose Rack, SS, Large
224160	Hose Rack, SS, Large Tilt

BACKFLOW PREVENTERS

- Designed for use on non-health-hazard, continuous pressure, point-of-use applications for protection against back siphoning and back pressure
- When installed upstream of a water-driven foamer or sprayer this part will prevent chemical solution and/or compressed air from backing up into the water source in the event of reverse suction (power failure, improper operation, failure to close inlet ball valves, etc.)
- Discharge vent can be plumbed to direct the discharge to an appropriate drainage area.
- May be mounted horizontally or vertically

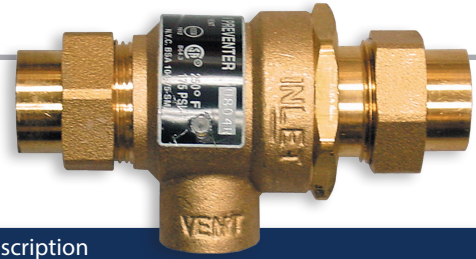

Model #	Description
270298	1/2" (Watts 9DM2) Backflow Preventer
270299	3/4" (Watts 9DM3) Backflow Preventer

WATER PRESSURE/FLOW TEST KIT

- Provides quick confirmation of available water pressure and water flow at the equipment water inlet
- Connects to standard male garden hose fitting
- Use to determine equipment needed for existing setup or a new facility
- Also for use mounted in line with installed equipment to determine operational water pressure
- Troubleshoot existing setup
- Features three flow restrictors for testing standard flow, medium flow and high flow applicators

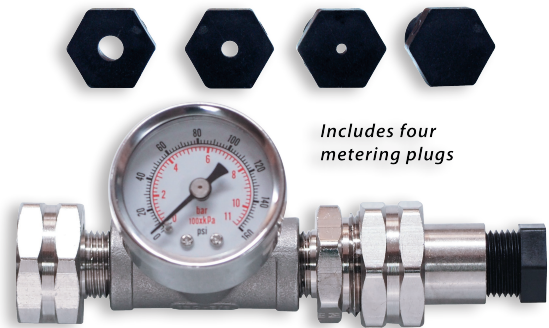

Includes four metering plugs

Model #	Description
336340	Water Pressure / Flow Test Kit

REQUIREMENTS / SPECIFICATIONS

Water Pressure Max.	160 PSI	11 bar
Water Flow Rate	@ 40 PSI	@ 2.8 bar
Small restrictor	1 gpm	3.8 lpm
Medium restrictor	4 gpm	15.1 lpm
Large restrictor	9 gpm	34.1 lpm

CHEMICAL DISPENSING ACCESSORIES:

SAFE FLOW™ JUG OR PAIL LIDS AND PAIL STICKS

- Safe and Convenient — Prevents splashing, reduces odor, and allows for quick replacement of chemical concentrate.
- **Jug / Pail Lids:** Machined polypropylene lids threaded to fit 1 gallon jugs and the pull-up spout of many 5 gallon pails.

- All models shown include a hose barb that attaches directly to any 1/4" suction tube of a Lafferty chemical applicator or dispenser.
- **Pail Sticks:** Polypropylene sticks with sliding collars, threaded to fit 3/4" container lid knockouts.

Model 709105 includes a 16" Pail Stick and 5 gallon pail with lid.

Jug Lid includes 1' of suction tubing. (Model 709101-R fits Rieke FLEXSPOUT® closures.) **Slip Stick** includes a sliding Jug Lid and fits containers up to 21" deep.

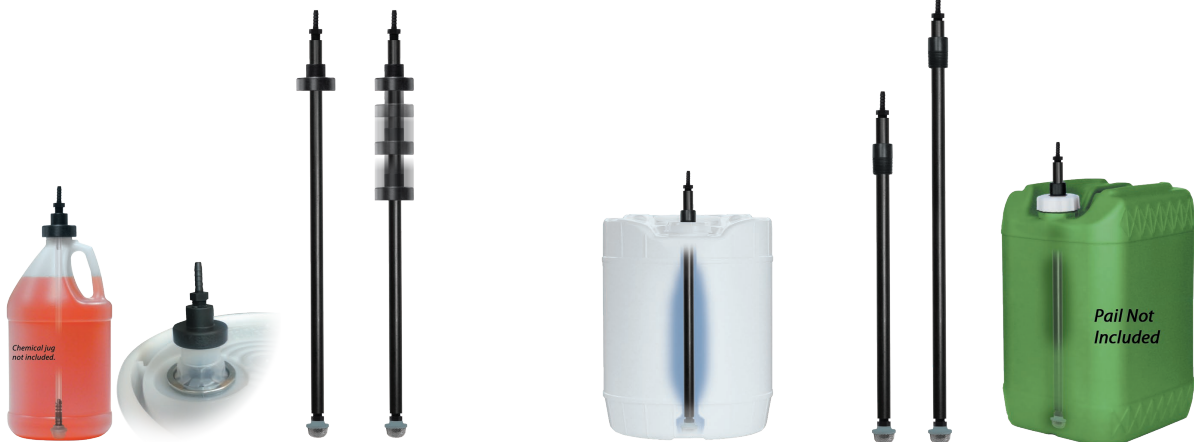

709101 (various models)
1 Gallon Safe Flow Lid w/
Flexible Tube & Strainer

491610 - 5 Gallon
Safe Flow Lid w/ Rigid
Tube & Strainer

709105 - 5 Gallon Pail
with Suction Stem

Safe Flow Pail Sticks
491617 - 16" (above, left)
491622 - 21" (above, right)

Pail Not
Included



LAFFERTY DRUM STICKS™ AND TOTE STICKS™ are chemical pick-up assemblies for use with pump-operated or venturi systems to draw chemical concentrates or diluted chemical solution directly from a drum, tote or holding tank.

Choice of seal material for optimum chemical resistance.

Choice of lengths with custom lengths available.

DRUM STICK / TOTE STICK

- Chemical/acid resistant polypropylene construction
- Connects to chemical pick-up tubes fitted to any venturi applicator or chemical pumping system
- Drum Bung Adaptor, machined to fit either coarse or fine-threaded bung holes, and Tote Stick Cover, for larger openings on totes and other bulk containers, keep trash out of chemical and allow easy depth adjustment of the Drum or Tote Stick.
- Rigid pipe overcomes problems common with flexible tubing
- Hastelloy strainer easily accessible for cleaning
- Choice of Viton or EPDM seals

SPECIFICATIONS

Polypropylene extension pipe

ID	3/4 in.	19.1 mm
Lengths:	Pipe Length	Inside Drum/Tote
33" Drum Stick	33 in. / 0.83 m	35 in. / 0.89 m
48" Drum Stick	48 in. / 1.22 m	50 in. / 1.27 m
54" Drum Stick	54 in. / 1.37 m	56 in. / 1.42 m
33" Tote Stick	33 in. / 0.8 m	36 in. / 0.91 m
48" Tote Stick	48 in. / 1.22 m	51 in. / 1.29 m
54" Tote Stick	54 in. / 1.37 m	57 in. / 1.45 m

Includes

- Machined polypropylene Drum Bung Adaptor with coarse and fine threads or 11" x 11" polypropylene Tote Stick Cover
- Four polypropylene hose bars:

1/4 in.	6.3 mm
3/8 in.	9.5 mm
1/2 in.	12.7 mm
3/4 in.	19.0 mm
- Polypropylene chemical check valve
- Hastelloy chemical strainer

***4-Way Drum Stick**
(can be used only with Mixing Stations or venturi units with check valve #491402 or #491401)

Model #	Description
491643	Drum Stick, 33" (Viton seals)
491643-E	Drum Stick, 33" (EPDM seals)
491644	4-Way Drum Stick, 33" (Viton seals)*
491644-E	4-Way Drum Stick, 33" (EPDM seals)*
491648	Drum Stick, 48" (Viton seals)
491648-E	Drum Stick, 48" (EPDM seals)
491649	4-Way Drum Stick, 48" (Viton seals)*
491645	Drum Stick, 54" (Viton seals)
491645-E	Drum Stick, 54" (EPDM seals)
491653	Tote Stick, 33" (Viton seals)
494653-E	Tote Stick, 33" (EPDM seals)
491654	Tote Stick, 48" (Viton seals)
491654-E	Tote Stick, 48" (EPDM seals)
491656	Tote Stick, 54" (Viton seals)
491656-E	Tote Stick, 54" (EPDM seals)

Drum/Tote Stick maximum reach inside drum or tote

Drum/Tote Stick Pipe Length

(Hose Barbs included)

Custom lengths available on request

METERING TIP DRIVER*

- Simply the best and easiest way to install or change metering tips across the entire Lafferty venturi product lineup.



Model #	Description
443790	Metering Tip Driver

* One Metering Tip Driver is included in each pack of metering tips enclosed with new venturi applicator orders.

NOTES:

INDUSTRIAL

LAFFERTY CATALOG SERIES

• Food & Beverage Processing • Pharmaceutical • Agriculture • General Industrial Applications



1 • Venturi Systems – City Water Pressure

2 • Venturi Systems – Boosted Pressure

3 • Venturi Systems – High Pressure

4 • Compressed Air Operated Systems

5 • Pump Fed Sanitizers, Foamers & Hose Drop Stations

6 • Entryway, Drain & Hand Sanitizing Systems

7 • Foggers and Fogging Systems

Special Applications

8 • Asphalt Release, Acid / Corrosive & Solvent Systems

9 • Chemical Management Systems

10 • Vehicle Wash & Detailing Systems

11 • JanSan / Commercial / Residential Systems

12 • Supermarket / Deli / Small Area Cleaning Systems

