

**5 Pump Fed Applicators and Central Chemical Feed Systems**

- Sanitizers
- Foamers
- Airless Foamers
- Rinse Stations
- Hose Drop Stations



# Lafferty

EQUIPMENT MANUFACTURING INC.®

**CATALOG 5**

**Pump Fed Applicators**  
*•Sanitizers •Foamers •Airless Foamers •Rinse Stations •Hose Drop Stations*  
**and Central Chemical Feed Systems**  
with Central System Planning Guide

# Chemical Application Equipment

[www.LaffertyEquipment.com](http://www.LaffertyEquipment.com)

5614 Oak Grove Road • North Little Rock, AR 72118

Phone: 800-999-2820 / 501-851-2820 • Fax Orders: 800-699-3719

**PUMP FED**

# Production and Environmental Sanitation Equipment

## Critical to Producing the Highest Quality Food Products

Regulations, public expectations and competitive pressures require business and industry to maintain clean production areas, machinery and equipment. In today's world, a pathogenic food contamination scare can panic people or cripple industries half a world away. Companies that are serious about cleaning invest in the best chemicals and the best chemical application equipment.

Lafferty builds quality into every piece of chemical application equipment – from the precision machining of our sanitizer and foamer bodies, to the careful selection of heavy-duty components, to the individual testing of every unit. This keeps Lafferty Equipment products working better and longer than any other brand.

Once you experience Lafferty quality and performance, you will know that no other brand can be "just like a Lafferty."

## Pump Fed Performance Perfection

Lafferty Pump Fed chemical applicators are designed for use with centralized chemical feed systems. Centralizing chemical storage, handling and mixing offers advantages from a chemical management and safety perspective. Ready-to-use (RTU) chemical solution is pumped to multiple sanitizers, foamers, airless foamers or hose drop stations.

Lafferty Pump Fed applicators feature design simplicity and outstanding durability. There are no moving or wearing parts and Lafferty's proprietary components are machined from chemical-resistant, solid, thermoplastics or stainless steel, to ensure long product life despite heavy, daily use or harsh environmental conditions.

For over 30 years, we at Lafferty have been perfecting our product offering through rigorous attention to detail and the manufacture of balanced systems, engineered to meet the needs of our customers. Our standard offering of pump fed applicators will meet all the daily chemical application needs of food processing plants. Additionally, custom-designed systems are available.

## Custom-Designed Pump Fed Systems

Through the years, Lafferty has created numerous variations of standard equipment — especially hose drop stations — to meet customer-specific applications. Tell us what you need, we may have your "custom solution" already sitting on our shelf. Otherwise, complete custom solutions are available and numerous minor modifications can be made "on the fly" to meet specific application challenges.

# Pump Fed Central Chemical Feed Systems

Lafferty Pump Fed chemical applicators are designed for use with centralized chemical feed systems. Lafferty offers all of the equipment (except piping) required to complete the installation of a Pump Fed Central System for foam cleaning and/or sanitizing at Food and Beverage production plants. The selection includes a range of compressed air pump-operated central chemical feed systems that deliver diluted chemical solution to multiple pump-fed units --sanitizers, foamers, airless foamers and hose drop stations-- along with a selection of Level Masters for maintaining a supply of RTU chemical solution in a holding tank.

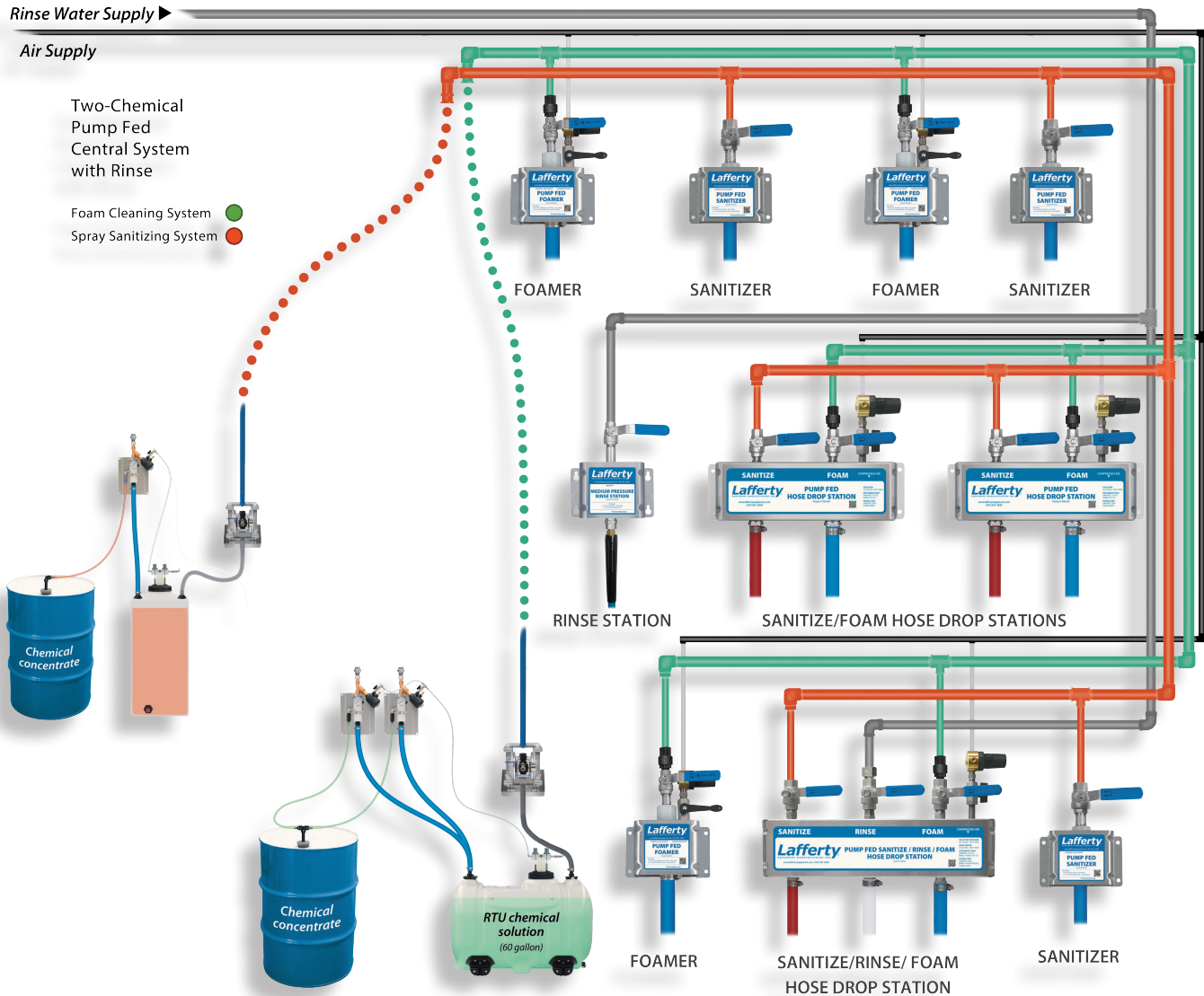

## PUMP FED CENTRAL SYSTEM PLANNING

Pages 4 through 7 will guide you through the details for planning a complete Pump Fed Central System. For additional details, tutorials and interactive tools, please visit the following page address at our website:

[www.laffertyequipment.com/tools/pump-fed-central-system-planning/](http://www.laffertyequipment.com/tools/pump-fed-central-system-planning/)

Applicators (foam, sanitize, rinse), dilution systems, pumping systems, and accessories are detailed beginning at page 8.

## Pump Fed Central System Planning Tool Worksheet

Use this worksheet to summarize the information that you will be asked to enter into the Planning Tool settings. The Planning Tool and further details and explanations are available at...

[www.laffertyequipment.com/tools/pump-fed-central-system-planning/](http://www.laffertyequipment.com/tools/pump-fed-central-system-planning/)

- This tool plans for up to 2 foaming chemicals and 1 sanitizing chemical. If additional foaming or sanitizing chemicals are desired, use the tool separately for each set of 3 chemicals.
- Use the table to list the applicators you plan to install
  - Choose from Foamers / Airless Foamers / Sanitizers / Rinse Stations / Hose Drop Stations and indicate how many of each model are likely to be used simultaneously.

Model Number	Description	Number of Units Required	Units Running Simultaneously

- List your rinse water pressure(s)
  - If no rinse is desired, leave the default values in the tool (they will not affect other calculations).
    - City water pressure?    \_\_\_ PSI (*Acceptable range is 35-125 PSI*)
    - Boosted water pressure? \_\_\_ PSI (*Acceptable range is 125-350 PSI*)
    - High water pressure?    \_\_\_ PSI (*Acceptable range is 400-1000 PSI*)
- List the output pressure of the pumping system(s)
  - Lafferty AODD Pumps are pre-set at 65 PSI. If you plan to use a Lafferty Pump, use the default value of 65 PSI. If you are using a different pump, enter the output pressure.
    - Foaming Chemical A    \_\_\_ PSI
    - Foaming Chemical B    \_\_\_ PSI
    - Sanitizing Chemical    \_\_\_ PSI
- List the distance of the furthest applicator from the pumping system(s)
  - Typically the pumping system is located alongside the dilution system, often away from the production floor in a chemical room. The tool makes calculations relative to the furthest unit to ensure adequate pipe sizes for the entire system.
    - Maximum distance from pumping system    \_\_\_ feet (*Acceptable range is 10-3000 feet*)

**FOUR STEPS TO PLANNING A PUMP FED CENTRAL SYSTEM** – The four main components of a Pump Fed Central System are (1) Applicators, (2) the Dilution System, (3) the Pump System, and (4) the Piping System. A comprehensive central system often consists of three separate applicator systems designed to work in concert — one each for foam cleaning, rinsing and sanitizing. Use the worksheet on page 4 to organize your planning data. — The worksheet is also available online at [www.laffertyequipment.com/uploads/documents/CentralSystemWorksheet.pdf](http://www.laffertyequipment.com/uploads/documents/CentralSystemWorksheet.pdf)

## STEP 1: APPLICATORS

FOAMERS, AIRLESS FOAMERS, SANITIZERS, RINSE UNITS, MULTIFUNCTION HOSE DROP STATIONS

- Browse the full line of Lafferty pump fed chemical applicators and rinse equipment and select the type and quantity of applicators to be installed.
- **Required Information:**
  - Unit model number of each type applicator to be installed
  - The number of each type of applicator — foamer or sanitizer — that will be in use at the same time
  - Provide the available rinse water pressure if any rinse equipment is selected, inclusive of multifunction applicators with a rinse function

### RESOURCE INFORMATION:

- **Single Function Applicators** – pages 8-11, Catalog 5  
Pump Fed Foamers, Pump Fed Sanitizer, rinse units  
Also online @ <http://www.laffertyequipment.com/products/pump-fed-central-systems/pump-fed-applicators/>
- **Multifunction Applicators** – pages 12-21, Catalog 5  
Pump Fed Hose Drop Stations, available in seven standard configurations:
  - Rinse / Foam, • Foam / Foam, • Foam / Rinse / Foam, • Sanitize / Foam,
  - Foam / Foam / Sanitize, • Sanitize / Sanitize / Foam, • Sanitize / Rinse / Foam
- See *Additional Required and Recommended Pump Fed System Components*, page 7

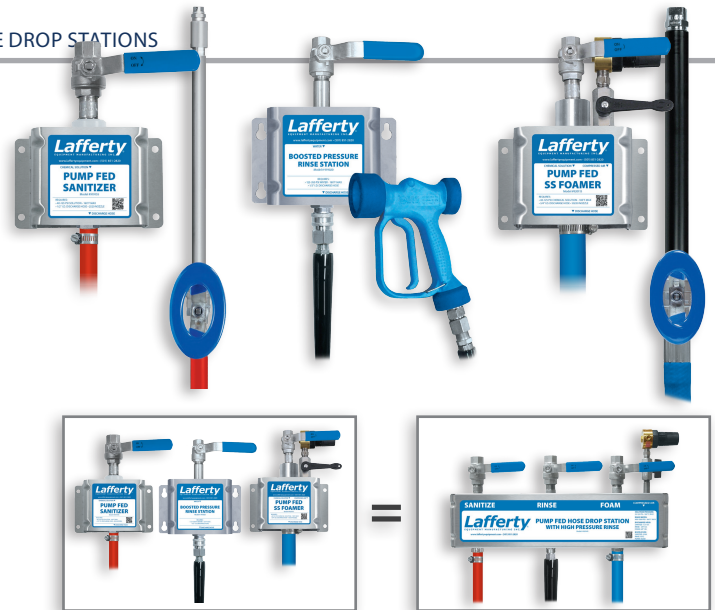

## STEP 2: DILUTION SYSTEMS

- The dilution system for each chemical solution must be sized to accommodate the total flow requirement of the pump fed applicators attached to the Central System and which will be in use at the same time.
- **Required Information:**
  - The piping distance from the pump system to the furthest applicator
  - The number of applicators to be in use at the same time (as indicated in Step 1, above)
- The same information is required to correctly size the dilution system, the pump system and the piping system for each central chemical feed system.
- For typical food plant installations, the Lafferty Pump Fed Central System Planning Tool online will recommend the appropriate High Flow Level Master System based on the applicators selected and other data you input.
- For smaller central systems or other special considerations, other Level Master Systems are available and, also, a Dosatron Injector Panel.
- Lafferty Level Master Systems are float valve activated proportioners that maintain a holding tank of ready-to-use chemical solution.
- Dosatron Injectors are water-driven, non-electrical, proportional dispensing systems that dilute chemical concentrates to required ratios and deliver RTU chemical solution to pump fed applicators.

### RESOURCE INFORMATION:

- **High Flow Level Masters** – pages 22-23, Catalog 5  
(Online @ [www.laffertyequipment.com/products/pump-fed-central-systems/pumps-level-master-systems/](http://www.laffertyequipment.com/products/pump-fed-central-systems/pumps-level-master-systems/))
- **Other Level Masters** – (view online only) – [www.laffertyequipment.com/products/pump-fed-central-systems/pumps-level-master-systems/](http://www.laffertyequipment.com/products/pump-fed-central-systems/pumps-level-master-systems/)
- **Dosatron Single Panel** – (view online only) - [www.laffertyequipment.com/products/909900-d/](http://www.laffertyequipment.com/products/909900-d/)

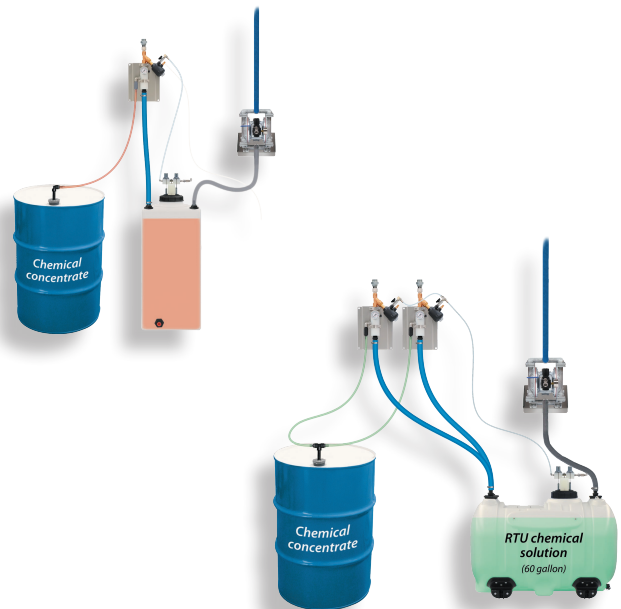

**FOUR STEPS TO PLANNING A PUMP FED CENTRAL SYSTEM** – (Continued from previous page)

**STEP 3: PUMP SYSTEMS**

- The pump system for each chemical solution must be sized to accommodate the total flow and solution pressure requirement of the pump fed applicators attached to the Central System and which will be in use at the same time.
- For typical food plant installations, the Lafferty Pump Fed Central System Planning Tool online will recommend the appropriate Central Pump System or Mini-Central Pump System based on the applicators selected and other data you input.
- **Required Information:**
  - The piping distance from the pump system to the furthest applicator
  - The number of applicators to be in use at the same time (as indicated in Step 1, above)
  - If a non-Lafferty chemical pumping system is being used, provide the pump solution pressure(s).
- For smaller central systems or other special considerations, a Dosatron Injector Panel can serve to both dilute chemical and deliver the RTU chemical solution to pump fed applicators, if water pressure is adequate. Dosatron Injectors are water-driven, non-electrical, proportional dispensing systems.

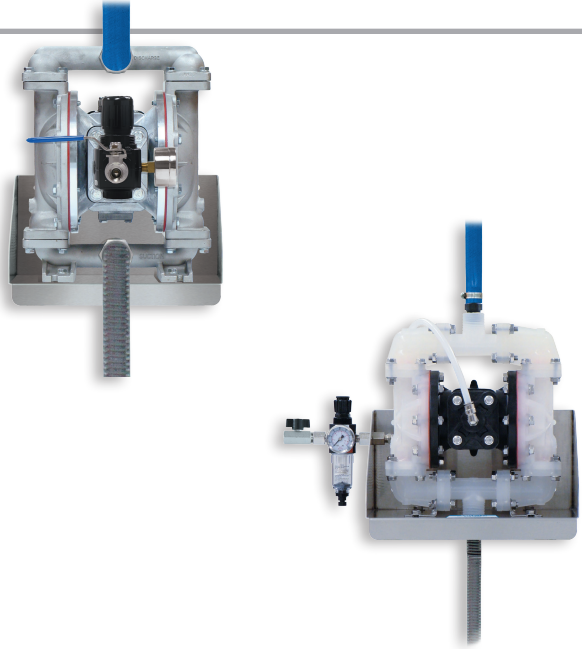

**RESOURCE INFORMATION:**

- **Central and Mini-Central Pump Systems** – page 24, Catalog 5  
(Also online @ [www.laffertyequipment.com/products/pump-fed-central-systems/pumps-level-master-systems/](http://www.laffertyequipment.com/products/pump-fed-central-systems/pumps-level-master-systems/))
- **Dosatron Single Panel** – (view online only) - [www.laffertyequipment.com/products/909900-d/](http://www.laffertyequipment.com/products/909900-d/)

**STEP 4: PIPING SYSTEMS**

- The piping system for each chemical solution must be sized to deliver a minimum of 35 PSI solution pressure to each of the applicator units that will be in use at the same time.
- Lafferty does not sell or install piping. However, to assist in calculating the correct piping header size, the Lafferty Pump Fed Central System Planning Tool will calculate the optimum chemical solution pipe sizing required, based on the applicators selected and other data you input.
- **Required Information:**
  - All information required by Steps 1, 2 and 3
- NOTE 1: Compressed air supply lines required by Pump Fed Foamers are not included as part of the Planning Tool or this Planning Guide.
- NOTE 2: Rinse water supply piping is not included as part of the Planning Tool or this Planning Guide.

**RESOURCE INFORMATION:**

- The Lafferty Pump Fed Central System Planning Tool  
[www.laffertyequipment.com/tools/pump-fed-central-system-planning/](http://www.laffertyequipment.com/tools/pump-fed-central-system-planning/)
- The Pump Fed Central System Planning Tool Worksheet – page 4

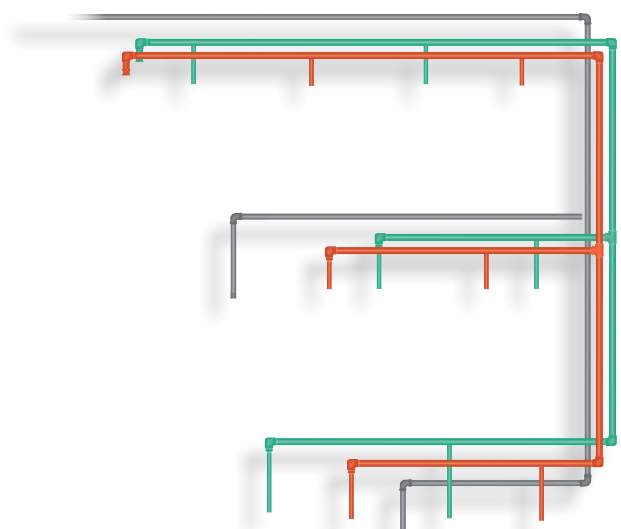

PUMP FED CENTRAL SYSTEM PLANNING GUIDE

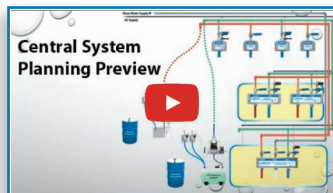

Video tutorial

- View the *Central System Planning Preview* video at the following web address:  
<http://www.laffertyequipment.com/tools/pump-fed-central-system-planning/>

## ADDITIONAL REQUIRED AND RECOMMENDED PUMP FED SYSTEM COMPONENTS

After pump fed applicators are chosen (see *Step 1: Applicators*, page 5), additional required and recommended system components should be considered and selected before moving on to select the Proportioning Systems and the Central Chemical Feed Pump Systems. **Contact us for guidance.**

Accessories —Hose Racks, Hose Reels, Drum Sticks, Tote Sticks— and other complementary items are listed beginning on page 25 of Catalog 5.

### Required Components

#### FOAMING CHEMICAL SOLUTION INLET CHECK VALVE

- A check valve is **required** on the solution inlet to a Pump Fed Foamer to help prevent compressed air from flowing back to the pump system and damaging the facility (under certain non-compliant operating conditions).
- NOTE: A check valve is **not** required for Airless Foamers
- The choice of check valve seal material will depend upon the intended chemical's compatibility.
- The stainless steel check valve should always be chosen in cases where the applicator is removed from its supporting stainless steel base, as well as when Teflon will be the preferred seal material.

**Contact us for guidance**

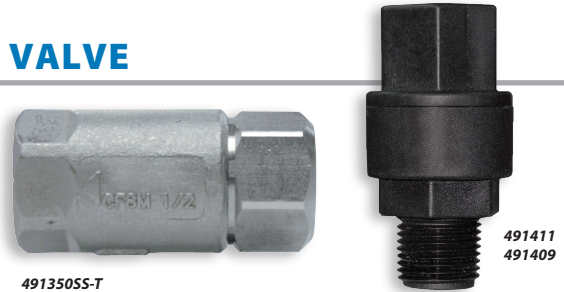

Model #	Description
491411	Check Valve, PP, Viton
491409	Check Valve, PP, EPDM
491350SS-T	Check Valve, SS, Teflon

### Recommended Components

#### SOLUTION STRAINERS

- Install a strainer to prevent problems from solution piping debris.
- New or old piping may contain plumbing or corrosion debris.
- To prevent blocking the small jets in the units, flush any new solution and compressed air plumbing of all debris before connecting.

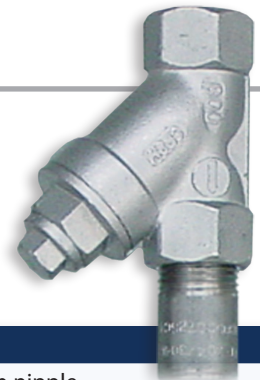

Model #	Description
150350-1	Strainer, "Y" SS, 1/2" with nipple

#### EXTRA AIR CHECK VALVE

- If compressed air to the unit is not supplied on a dedicated airline, it is recommended to install an additional check valve on the shared airline to help avoid potential damage to other equipment in the event of an air check valve failure.
- Installed check valve is EPDM - additional check valve should be Viton.

**Contact us for guidance**



Model #	Description
491306	Check Valve, SS, Viton (Hastelloy spring)
491302	Check Valve, SS, EPDM (Hastelloy spring)

#### AIR FILTER

- If compressed air piping is older or has known contaminants, this debris may become dislodged and block the air check valve from closing.
- Install a suitable standard compressed airline filter.

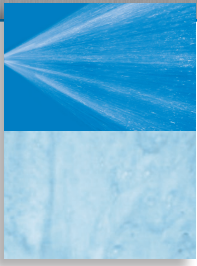

**LAFFERTY PUMP FED SANITIZERS AND FOAMERS** are designed for use with RTU chemical solution supplied by a central chemical feed system and feature flow control restrictors to prevent waste.

Lafferty Pump Fed Sanitizers produce an even spray fan pattern for quick area coverage.

Lafferty Pump Fed Foamers produce and project high quality foam, providing for superior cleaning and visual assurance of complete coverage on any surface. Models offer three foam volumes and throw distances; The optimum model to use will be determined by the application and desired coverage speed.

Offered with Lafferty's signature heavy-duty stainless steel mounting enclosure or bracket.

## PUMP FED SANITIZER

REQUIRES: RTU CHEMICAL @ 35 - 125 PSI SOLUTION PRESSURE

- For use with RTU chemical solution supplied by a central chemical feed system

### REQUIREMENTS / SPECIFICATIONS

<b>Solution Pressure</b>	<b>35 - 125 PSI</b>	<b>2.4 - 8.6 bar</b>
<b>Solution Flow Rate*</b>	<b>@ 40 PSI</b>	<b>@ 2.8 bar</b>
	1.7 gpm*	6.4 lpm

### Discharge Hose

ID	1/2 in.	12.7 mm
Length	50 ft.	15.2 m

### Includes

- Machined polypropylene sanitizer body
- Stainless steel mounting enclosure
- Stainless steel solution inlet ball valve
- Discharge hose with stainless steel ball valve, wand and nozzle

\* Custom flow rates available on request

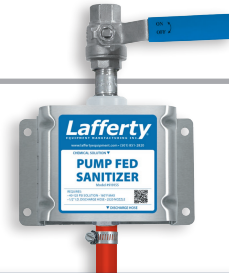

Model #	Description
919155	Pump Fed Sanitizer



## PUMP FED AIRLESS FOAMERS

REQUIRES: RTU CHEMICAL @ 35 - 125 PSI SOLUTION PRESSURE

- For use with RTU chemical solution supplied by a central chemical feed system
- Lafferty Airless Foamers do not require compressed air, eliminating cost and equipment adjustment issues.
- Foam is created instantly by the venturi airless foam wand.
- Usable foam throw distance of up to 8 ft. — Increased solution pressure will increase foam throw.

### REQUIREMENTS / SPECIFICATIONS

<b>Solution Pressure</b>	<b>35 - 125 PSI</b>	<b>2.4 - 8.6 bar</b>
<b>Solution Flow Rate</b>	<b>@ 40 PSI</b>	<b>@ 2.8 bar</b>
	1.7 gpm	6.4 lpm

### Discharge Hose

ID	1/2 in.	12.7 mm
Length	50 ft.	15.2 m

### Includes

- Machined polypropylene foamer body
- Stainless steel mounting enclosure
- Stainless steel solution inlet ball valve
- Discharge hose, stainless steel ball valve and machined stainless steel airless foam wand



Model #	Description
920905	Pump Fed Airless Foamer

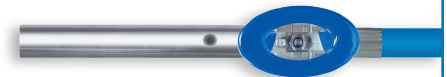

## PUMP FED FOAMERS

REQUIRES: RTU CHEMICAL @ 35 - 125 PSI SOLUTION PRESSURE, COMPRESSED AIR

- For use with RTU chemical solution supplied by a central chemical feed system
- Medium volume output for all foaming applications or low flow (LF) for precise foaming applications
- Usable foam throw distance of up to 12 ft. (3.7 m)
- Covers up to 500 ft<sup>2</sup> (46.5 m<sup>2</sup>) in 2 minutes

### REQUIREMENTS / SPECIFICATIONS

#### Compressed Air

LF	<b>2 cfm</b>	<b>56.6 lpm</b>
920105 (up to)	<b>3 cfm</b>	<b>85.0 lpm</b>
920115 (up to)	<b>4 cfm</b>	<b>113.3 lpm</b>

**Solution Pressure** 35 - 125 PSI 2.4 - 8.6 bar

**Solution Flow Rate** @ 40 PSI @ 2.8 bar

LF	0.6 gpm	2.3 lpm
920105; 920115	1.7 gpm	7.6 lpm

#### Discharge Hose

ID	3/4 in.	19.1 mm
Length	50 ft.	15.2 m

#### Includes

- Machined polypropylene or stainless steel foamer body
- Stainless steel mounting enclosure
- Stainless steel solution inlet ball valve
- Discharge hose with stainless steel ball valve, wand and fan nozzle

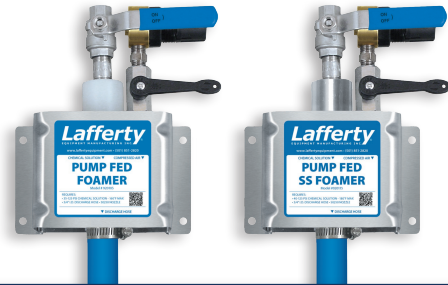

Model #	Description
920105-LF	Pump Fed LF Foamer
920105	Pump Fed Foamer
920115	Pump Fed SS Foamer



Foam discharge hose assembly

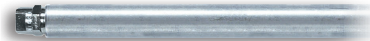

Upgrade Option for Units listed above: Stainless Steel Foam Wand upgrade when ordering with unit. Request item # 536603-X.

## PUMP FED XV FOAMER

REQUIRES: RTU CHEMICAL @ 35 - 100 PSI SOLUTION PRESSURE, COMPRESSED AIR

- For use with RTU chemical solution supplied by a central chemical feed system
- High volume output for foaming large surface areas
- Usable foam throw distance of up to 15 feet with standard fan nozzle
- Covers up to 500 ft<sup>2</sup> (46.45 m<sup>2</sup>) in 1 minute

### REQUIREMENTS / SPECIFICATIONS

**Compressed Air** 6 cfm 169.9 lpm

**Solution Pressure** 35 - 100 PSI 2.4 - 6.9 bar

**Solution Flow Rate** @ 40 PSI @ 2.8 bar

XV Foamer	4.0 gpm	15.1 lpm
-----------	---------	----------

#### Discharge Hose

ID	1 in.	25.4 mm
Length	50 ft.	15.2 m

#### Includes

- Machined polypropylene foamer body
- Stainless steel mounting bracket
- Stainless steel solution inlet ball valve
- Discharge hose with stainless steel ball valve, foam wand and fan nozzle

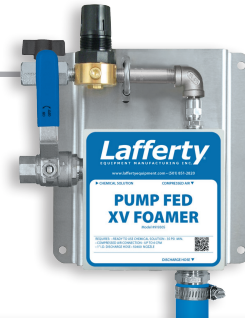

Model #	Description
919305	Pump Fed XV Foamer



Upgrade Option for Unit listed above: Stainless Steel Foam Wand upgrade when ordering with unit. Request item # 536605SS-X.

### Multifunction Systems (Hose Drop Stations)

- The most basic central system consists of single-function applicators — foamers / sanitizers / rinse stations — connected to their respective supply piping system. Hose Drop Stations replace the function of two or more single-function applicators. Lafferty offers a variety of standard and custom Hose Drop Station configurations. (See page 12)

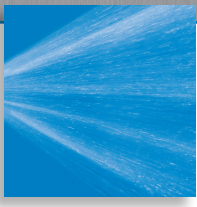

**LAFFERTY RINSE STATIONS** are designed for both pre-clean and post-clean rinsing of a variety of surfaces in and around food and beverage plants. Constructed with stainless steel components, Rinse Stations can be equipped with optional, water-conserving flow restrictors.

Lafferty Rinse Stations are offered for three water pressure ranges: • City Water Pressure, 35–125 PSI • Boosted Pressure, 125–350 PSI • High Pressure, 400–2000 PSI.

## RINSE STATIONS

REQUIRES: WATER PRESSURE AND SPRAY GUN / NOZZLE SPECIFIED FOR SELECTED MODEL

- For rinsing down medium to large surfaces and objects
- All stainless steel components ensure years of outstanding performance with minimal maintenance.
- Industrial-strength design holds up in tough environments.
- Water pressure / flow-matched trigger guns and nozzles produce hard-hitting, impinging rinse.

### Optional Water Conservation Flow Restrictors

- Controls water consumption: Machined stainless steel, in-line flow restrictor limits the amount of water per minute that can be discharged.
- Restrictors, rinse nozzles and trigger guns are matched to the water pressure range to provide maximum results with minimal water use
- Flow restriction stays active even if hose or rinse gun / nozzle are changed or removed.
- Lowers sewer costs due to decreased water usage.

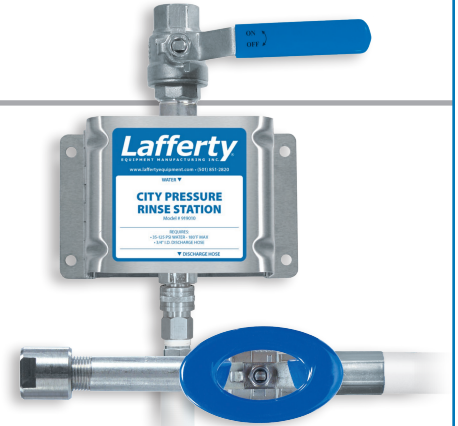

919010



(Trigger gun not to scale with unit.)

919015



(Trigger gun not to scale with unit.)

919020

Model		Max Temp	Water Flow GPM	Supply Line	Hose	Gun / Nozzle
919010	City Water Pressure Rinse Station (35–125 PSI)	180°F	7.2 @ 40 PSI	3/4 in.	3/4 in. x 50 ft.	Stainless Steel Ball Valve & Lafferty SS 4-Hole Nozzle
919020	Boosted Pressure Rinse Station (125–350 PSI)	180°F	13.4 @ 250 PSI	3/4 in.	1/2 in. x 50 ft. High Pressure	Adjustable spray pattern trigger gun
919015	High Pressure Rinse Station (400–1000 PSI)	180°F	4.6 @ 700 PSI	3/8 in.	3/8 in. x 50 ft. High Pressure	Trigger Gun, Stainless Steel Wand, 5° Stainless Steel Nozzle (Optional nozzles available for higher or lower flow rates)

**STRAHMAN MIXING UNITS – HOSE STATIONS** are designed to thoroughly mix hot and cold water in any proportion. Temperature indicating (TG) models are equipped with a blending chamber and quick-acting, dial-type, dual Fahrenheit/Celsius temperature gauge, which accurately indicates the water's temperature exiting the specially designed blending chamber.

Mixing Units are of stainless steel construction and are offered with premium wrapped food grade hose, with stainless steel fittings, and heavy duty stainless steel spray nozzle.

## HOT AND COLD WATER MIXING UNIT

REQUIRES: WATER UP TO 150 PSI AND UP TO 200°F/93°C

- Stainless steel construction with integral stainless steel hose rack
- Simple visual recognition of valve position
- Easy to maintain and replace globe valves with reduced wrist fatigue
- Flow rates adjustable from low to high
- *Not suitable for steam service*

### SPECIFICATIONS

Maximum Water Temperature	200°F	93°C
Maximum Working Pressure	150 PSI	10.3 bar

### Food Grade Hose Assembly

RATED FOR UP TO 150 PSI AND UP TO 200°F/93°C

- Premium wrapped white hose
- General purpose hose for food, water and air with FDA approved tube — food grade hose
- Oil, fat and chemical resistant
- Stainless steel fittings and stainless steel internal spring assemblies on both ends for added durability and extended hose life.
- Safe, reliable and easy to maintain

### SPECIFICATIONS (SEE BELOW)

### Automatic Water Saver Spray Nozzle

RATED FOR UP TO 150 PSI AND UP TO 200°F/93°C

- Stainless steel construction – strong enough to withstand even the most rugged applications
- Stainless steel seat design prevents nozzle seat leakage
- Instant water shut-off when trigger is released
- Long handle design grip for whole hand placement
- Replaceable heavy duty rubber cover
- *Not suitable for steam service*

### SPECIFICATIONS

Maximum Water Temperature	200°F	93°C
Maximum Working Pressure	150 PSI	10.3 bar
Hose:		
ID	5/8 in	1.6 cm
OD	1 1/8 in	2.9 cm
Length	50 ft.	15.2 m
Nozzle Flow Rate	5 gpm	18.9 lpm
	@ 50 PSI	@ 2.7 bar



Model #	Description
919027	Hot / Cold Water Mixing Unit, SS, Complete
919027-UNIT	Hot / Cold Water Mixing Unit, SS (NO HOSE / NOZZLE)



PUMP FED SINGLE-FUNCTION APPLICATORS

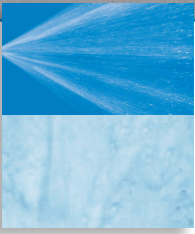

**LAFFERTY PUMP FED HOSE DROP STATIONS** are multifunction chemical applicators that combine multiple Foamers, Sprayers/Sanitizers, and Rinse Stations into one convenient unit. Foamer models are offered with standard compressed-air-assisted foamers or with Airless Foamers that do not require compressed air. Rinse units are available for City Pressure, Boosted Pressure and High Pressure systems.

Offered with Lafferty's signature heavy-duty stainless steel mounting enclosure.

## PUMP FED HOSE DROP STATIONS STANDARD CONFIGURATIONS

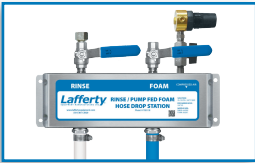

Rinse / Pump Fed Foam .....page 18  
*Airless Foam model available*

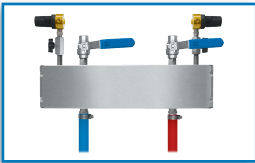

Pump Fed Foam / Foam .....page 17



Pump Fed Foam / Rinse / Foam .....page 21

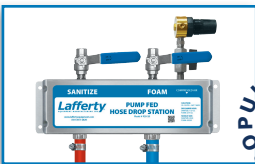

Pump Fed Sanitize / Foam .....page 13  
*Airless Foam model available*

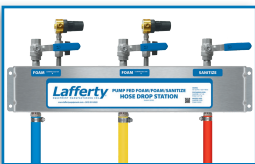

Pump Fed Foam / Foam / Sanitize .....page 19

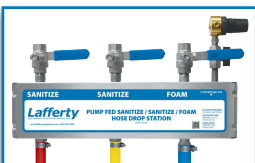

Pump Fed Sanitize / Sanitize / Foam .....page 20

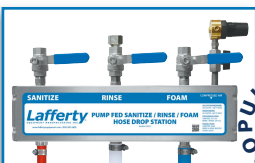

Pump Fed Sanitize / Rinse / Foam .....pages 14-16  
 Also available as Airless Foam model or with Boosted or High Pressure Rinse.



Custom Hose Drop Station Combinations .....page 17

## PUMP FED SANITIZE / FOAM HOSE DROP STATION

REQUIRES: RTU CHEMICAL @ 35 - 125 PSI SOLUTION PRESSURE + COMPRESSED AIR

- For use with RTU chemical solution supplied by a central chemical feed system
- Lafferty Sanitize/Foam Hose Drop Stations are convenient combination systems that will apply one chemical solution as foam and a second as a sanitizing spray.
- The Pump Fed Foamers provide medium volume output for all foaming applications.
- Usable foam throw distance of up to 12 ft. (3.7 m)
- Covers up to 500 ft<sup>2</sup> (46.5 m<sup>2</sup>) in 2 minutes

### REQUIREMENTS / SPECIFICATIONS

<b>Compressed Air</b>	<b>4 cfm</b>	<b>113.3 lpm</b>
<b>Solution / Water Pressure</b>	<b>35 - 125 PSI</b>	<b>2.4 - 8.6 bar</b>
<b>Solution Flow Rate</b>	<b>@ 40 PSI</b>	<b>@ 2.7 bar</b>
Sanitize	1.7 gpm	6.4 lpm
Foam	1.7 gpm	6.4 lpm
<b>Discharge Hoses</b>		
ID		
Sanitize	1/2 in.	12.7 mm
Foam	3/4 in.	19.1 mm
Length	50 ft.	15.2 m

### Includes

- Machined polypropylene or stainless steel sanitizer and foamer bodies
- Stainless steel mounting enclosure
- Stainless steel solution inlet ball valves
- Two discharge hose assemblies:
  - Sanitize: Red hose with stainless steel ball valve, stainless steel wand and fan nozzle
  - Foam: Blue hose with stainless steel ball valve, polypropylene wand and fan nozzle



Model #	Description
920120	Pump Fed Sanitize / Foam HDS
920120SS	Pump Fed SS Sanitize / SS Foam HDS



Sanitize discharge hose assembly



Foam discharge hose assembly

Upgrade Option for Unit listed above: Stainless Steel Foam Wand upgrade when ordering with unit. Request item # 536603-X.

## PUMP FED SANITIZE / AIRLESS FOAM HOSE DROP STATIONS

REQUIRES: RTU CHEMICAL @ 35 - 125 PSI SOLUTION PRESSURE

- Lafferty Sanitize / Airless Foam Hose Drop Stations are convenient combination systems that will apply one chemical solution as a high quality, wet foam —without the need for compressed air— and a second solution as a sanitizing spray.
- Medium volume output for all foaming applications. A high quality, wet foam is created instantly by the venturi airless foam wand and projected onto any surface.
- Usable foam throw distance of up to 9 feet
- Covers up to 500 ft.<sup>2</sup> (46.5 m<sup>2</sup>) in 2 minutes

### REQUIREMENTS / SPECIFICATIONS

<b>Solution Pressure</b>	<b>35 - 125 PSI</b>	<b>2.4 - 8.6 bar</b>
<b>Solution Flow Rate</b>	<b>@ 40 PSI</b>	<b>@ 2.8 bar</b>
Sanitize	1.7 gpm	6.4 lpm
Airless Foam	1.7 gpm	6.4 lpm
<b>Discharge Hoses</b>		
ID		
Sanitize	1/2 in.	12.7 mm
Length	50 ft.	15.2 m

### Includes

- Machined polypropylene bodies
- Stainless steel ball valves
- Stainless steel mounting enclosure
- Two discharge hose assemblies:
  - Sanitize: Red hose with stainless steel ball valve, stainless steel wand and fan nozzle
  - Foam: Blue hose with stainless steel ball valve and machined stainless steel airless foam wand



Model #	Description
920920	Pump Fed Sanitize / Airless Foam HDS



Sanitize discharge hose assembly



Airless foam discharge hose assembly

PUMP FED SINGLE-FUNCTION APPLICATORS

## PUMP FED SANITIZE / RINSE / FOAM HOSE DROP STATIONS

REQUIRES: RTU CHEMICAL @ 35 - 125 PSI SOLUTION PRESSURE, RINSE WATER PRESSURE, COMPRESSED AIR

- For use with RTU chemical solution supplied by a central chemical feed system
- Lafferty Sanitize/Rinse/Foam Hose Drop Stations are convenient combination systems that will apply one chemical as foam, rinse, and apply a second chemical as a sanitizing spray.
- Medium volume output for all foaming applications
- Usable foam throw distance of up to 12 ft. (3.7 m)
- Covers up to 500 ft<sup>2</sup> (46.5 m<sup>2</sup>) in 2 minutes

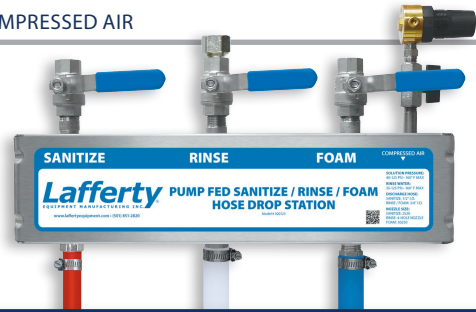

### REQUIREMENTS / SPECIFICATIONS

<b>Compressed Air</b>	<b>4 cfm</b>	<b>113.3 lpm</b>
<b>Solution / Water Pressure</b>	<b>35 - 125 PSI</b>	<b>2.4 - 8.6 bar</b>
<b>Solution Flow Rate</b>	<b>@ 40 PSI</b>	<b>@ 2.7 bar</b>
Sanitize	1.7 gpm	6.4 lpm
Foam	1.7 gpm	6.4 lpm
<b>Water Flow Rate</b>		
Rinse	7.2 gpm	27.3 lpm
<b>Discharge Hose</b>		
ID		
Sanitize	1/2 in.	12.7 mm
Rinse & Foam	3/4 in.	19.1 mm
Length	50 ft.	15.2 m



Model #	Description
920125	Pump Fed Sanitize/Rinse/Foam HDS
920125SS	Pump Fed SS Sanitize/Rinse/SS Foam HDS

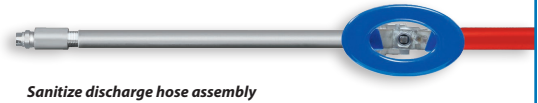

Sanitize discharge hose assembly



Rinse hose assembly with Lafferty's unique 4-hole stainless steel rinse nozzle



Foam discharge hose assembly



Upgrade Option for Units listed this page: Stainless Steel Wand upgrade when ordering with unit. Request item # 536603-X.

### Includes

- Machined polypropylene or stainless steel foamer and sanitizer bodies
- Stainless steel mounting enclosure
- Stainless steel solution / water inlet ball valves
- Three discharge hose assemblies:
  - Sanitize: Red hose with stainless steel ball valve, stainless steel wand and fan nozzle
  - Rinse: White hose with stainless steel ball valve and Lafferty's machined stainless steel 4-hole rinse nozzle
  - Foam: Blue hose with stainless steel ball valve, polypropylene wand and fan nozzle

## PUMP FED SANITIZE / RINSE / AIRLESS FOAM HOSE DROP STATIONS REQUIRES:

RTU CHEMICAL @ 35 - 125 PSI SOLUTION PRESSURE, RINSE WATER PRESSURE

- Lafferty Sanitize/Rinse / Airless Foam Hose Drop Stations are convenient combination systems that will apply one chemical solution as high quality, wet foam —without the need for compressed air, rinse and apply a second solution as a sanitizing spray.
- Medium volume output for all foaming applications. A high quality, wet foam is created instantly by the venturi airless foam wand and projected onto any surface.
- Usable foam throw distance of up to 8 feet
- Covers up to 500 ft.<sup>2</sup> (46.5 m<sup>2</sup>) in 2 minutes

### REQUIREMENTS / SPECIFICATIONS

<b>Solution / Water Pressure</b>	<b>35 - 125 PSI</b>	<b>2.4 - 8.6 bar</b>
<b>Solution Flow Rate</b>	<b>@ 40 PSI</b>	<b>@ 2.7 bar</b>
Sanitize	1.7 gpm	6.4 lpm
Airless Foam	1.7 gpm	6.4 lpm
<b>Water Flow Rate</b>		
Rinse	7.2 gpm	27.3 lpm
<b>Discharge Hoses</b>		
ID		
Sanitize & Airless Foam	1/2 in.	12.7 mm
Rinse	3/4 in.	19.1 mm
Length	50 ft.	15.2 m

### Includes

- Machined polypropylene foamer and sanitizer bodies
- Stainless steel mounting enclosure
- Stainless steel solution / water inlet ball valves
- Three discharge hose assemblies:
  - Sanitize: Red hose with stainless steel ball valve, stainless steel wand and fan nozzle
  - Rinse: White hose with stainless steel ball valve and Lafferty's machined stainless steel, 4-hole rinse nozzle
  - Foam: Blue hose with stainless steel ball valve and machined stainless steel airless foam wand and fan nozzle



Model #	Description
920925	Pump Fed Sanitize / Rinse / Airless Foam HDS



Sanitize discharge hose assembly

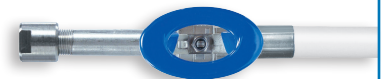

Rinse hose assembly with Lafferty's 4-hole rinse nozzle

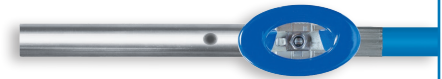

Airless foam discharge hose assembly

PUMP FED SINGLE-FUNCTION APPLICATORS

# Boosted Pressure (BP) or High Pressure (HP) Rinse

## PUMP FED SANITIZE / RINSE / FOAM HOSE DROP STATIONS

REQUIRES: RTU CHEMICAL @ 35 - 125 PSI SOLUTION PRESSURE, COMPRESSED AIR, RINSE WATER PRESSURE (BP OR HP)

- For use with RTU chemical solutions supplied by central chemical feed systems
- Lafferty Sanitize/Rinse/Foam Hose Drop Stations are convenient combination systems that will apply one chemical solution as foam, rinse, and apply a second solution as a sanitizing spray.
- Features a rinse function for use with boosted pressure water (150 to 350 PSI) or high pressure water (400 to 1000 PSI) depending on the model selected. Match the model to the plant water system.
- The Pump Fed Foamers provide medium volume output for all foaming applications.
- Usable foam throw distance of up to 12 ft. (3.7 m)
- Covers up to 500 ft<sup>2</sup> (46.5 m<sup>2</sup>) in 2 minutes



### REQUIREMENTS / SPECIFICATIONS

<b>Compressed Air</b>	(up to)	<b>3 cfm</b>	<b>85.0 lpm</b>
<b>Solution Pressure</b>		<b>35 - 125 PSI</b>	<b>2.4 - 8.6 bar</b>
<b>Solution Flow Rate</b>		<b>@ 40 PSI</b>	<b>@ 2.7 bar</b>
Sanitize		1.7 gpm	6.4 lpm
Foam		1.7 gpm	6.4 lpm
<b>Rinse Water Pressure</b>			
Boosted Pressure (BP)		150 to 350 PSI	10.3 to 24.1 bar
High Pressure (HP)		400 to 1000 PSI	27.6 to 68.9 bar
<b>Water Flow Rate (Rinse)</b>			
BP		<b>@ 250 PSI</b>	<b>@ 17.2 bar</b>
		13.4 gpm	50.7 lpm
HP		<b>@ 400 PSI</b>	<b>@ 27.6 bar</b>
		3.8 gpm	14.4 lpm

### Discharge Hose

ID		
Sanitize	1/2 in.	12.7 mm
Foam	3/4 in.	19.1 mm
BP Rinse	1/2 in.	12.7 mm
HP Rinse	3/8 in.	9.5 mm
Length	50 ft.	15.2 m

### Includes

- Machined polypropylene foamer and sanitizer bodies
- Stainless steel mounting enclosure
- Stainless steel solution/water inlet ball valves
- Three discharge hose assemblies:
  - Sanitize:** Red hose with stainless steel ball valve, stainless steel wand and fan nozzle
  - Rinse:** Pressure-rated hose with either Boosted Pressure trigger gun or High Pressure trigger gun, wand and nozzle
  - Foam:** Blue hose with stainless steel ball valve, polypropylene wand and fan nozzle



Model #	Description
<b>Boosted Pressure Rinse</b>	
920135	Pump Fed Sanitize / BP Rinse / Foam HDS
<b>High Pressure Rinse</b>	
920145	Pump Fed Sanitize / HP Rinse / Foam HDS



Sanitize discharge hose assembly



Foam discharge hose assembly



Upgrade Option for Unit listed above: Stainless Steel Foam Wand upgrade when ordering with unit. Request item # 536603-X.



Boosted Pressure Rinse: Pressure-rated hose and trigger gun with swivel

High Pressure Rinse: Pressure-rated hose, trigger gun, wand and matching fan nozzle. Shown with optional Insulator for 1/4" SS Wand (part #536500).

## STAINLESS STEEL HOSE REELS

See more details, page 26.



Model #	Description
224183-A <sup>†</sup>	Hose Reel, SS, 3/8" x 75', 300 PSI, w/Jumper Hose Kit Suitable for High Pressure Rinse Applicator #920145
224186-A <sup>†</sup>	Hose Reel, SS, 1/2" x 75', 300 PSI, w/Jumper Hose Kit Suitable for Boosted Pressure Rinse Applicator #920135

<sup>†</sup> Allow six weeks production time. Discharge hose and applicator wand not included.

## CUSTOM HOSE DROP STATION COMBINATIONS

Through the years, Lafferty has created numerous variations of standard equipment — especially hose drop stations — to meet customer-specific applications, as illustrated below. Tell us what you need, we may have your "custom solution" already sitting on our shelf. Otherwise, complete custom solutions are available and numerous minor modifications can be made "on the fly" to meet specific application challenges.



## PUMP FED FOAM / FOAM HOSE DROP STATION

REQUIRES: RTU CHEMICAL @ 35 - 125 PSI SOLUTION PRESSURE, COMPRESSED AIR

- For use with RTU chemical solution supplied by a central chemical feed system
- Lafferty Foam / Foam Hose Drop Stations will apply two chemical solutions
- Medium volume output for all foaming applications.
- Usable foam throw distance of up to 12 ft. (3.7 m)
- Covers up to 500 ft<sup>2</sup> (46.5 m<sup>2</sup>) in 2 minutes

### REQUIREMENTS / SPECIFICATIONS

<b>Compressed Air</b>	(up to)	<b>3 cfm</b>	<b>85.0 lpm</b>
<b>Solution / Water Pressure</b>		<b>35 - 125 PSI</b>	<b>2.4 - 8.6 bar</b>
<b>Solution Flow Rate</b>		<b>@ 40 PSI</b>	<b>@ 2.7 bar</b>
Foam		1.7 gpm	6.4 lpm
<b>Discharge Hoses</b>			
ID		3/4 in.	19.1 mm
Length		50 ft.	15.2 m

### Includes

- Machined polypropylene foamer bodies
- Stainless steel mounting enclosure and solution inlet ball valves
- Two discharge hose assemblies:  
**Foam:** Blue hose with stainless steel ball valve, polypropylene wand and fan nozzle  
**Foam:** Red hose with stainless steel ball valve, polypropylene wand and fan nozzle

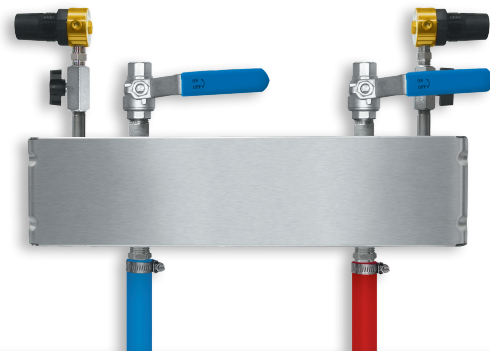

Model #	Description
920205	Pump Fed Foam / Foam HDS

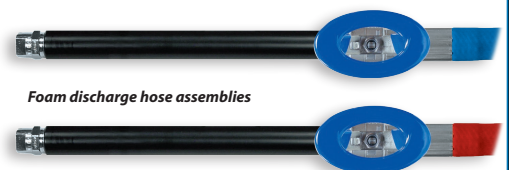

Upgrade Option for Units listed this page: Stainless Steel Foam Wand upgrade when ordering with unit. Request item # 536603-X.

PUMP FED SINGLE-FUNCTION APPLICATORS

## PUMP FED RINSE / FOAM HOSE DROP STATION

REQUIRES: RTU CHEMICAL @ 35 - 125 PSI SOLUTION PRESSURE, RINSE WATER PRESSURE, COMPRESSED AIR

- For use with RTU chemical solution supplied by a central chemical feed system
- Lafferty Rinse / Foam Hose Drop Stations are convenient combination systems that will apply one chemical solution as foam, and rinse.
- Medium volume output for all foaming applications
- Usable foam throw distance of up to 12 ft. (3.7 m)
- Covers up to 500 ft<sup>2</sup> (46.5 m<sup>2</sup>) in 2 minutes

### REQUIREMENTS / SPECIFICATIONS

<b>Compressed Air</b>	(up to)	<b>3 cfm</b>	<b>85.0 lpm</b>
<b>Solution / Water Pressure</b>		<b>35 - 125 PSI</b>	<b>2.4 - 8.6 bar</b>
<b>Solution Flow Rate</b>		<b>@ 40 PSI</b>	<b>@ 2.7 bar</b>
Foam		1.7 gpm	6.4 lpm
<b>Water Flow Rate</b>			
Rinse		7.2 gpm	27.3 lpm
<b>Discharge Hoses</b>			
ID		3/4 in.	19.1 mm
Length		50 ft.	15.2 m

### Includes

- Machined polypropylene foamer body
- Stainless steel mounting enclosure and solution inlet ball valves
- Two discharge hose assemblies:
  - Rinse: White hose with stainless steel ball valve and Lafferty's 4-hole rinse nozzle
  - Foam: Blue hose with stainless steel ball valve, wand and fan nozzle

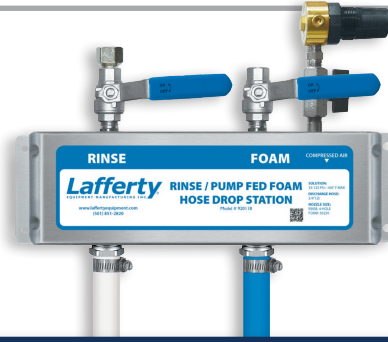

Model #	Description
920118	Rinse / Pump Fed Foam HDS



Rinse hose assembly with Lafferty's unique 4-hole stainless steel rinse nozzle



Foam discharge hose assembly



Upgrade Option for Units listed this page: Stainless Steel Foam Wand upgrade when ordering with unit. Request item # 536603-X.

## PUMP FED RINSE / AIRLESS FOAM HOSE DROP STATION

REQUIRES: RTU CHEMICAL @ 35 - 125 PSI SOLUTION PRESSURE, RINSE WATER PRESSURE

- For use with RTU chemical solution supplied by a central chemical feed system
- Lafferty Rinse / Airless Foam Hose Drop Stations are convenient combination systems that will apply one chemical solution as airless foam, and rinse.
- Medium volume output for all foaming applications. Foam is created instantly by the venturi airless foam wand.
- Usable foam throw distance of up to 8 feet
- Covers up to 500 ft.<sup>2</sup> (46.5 m<sup>2</sup>) in 2 minutes

### REQUIREMENTS / SPECIFICATIONS

<b>Solution / Water Pressure</b>		<b>35 - 125 PSI</b>	<b>2.4 - 8.6 bar</b>
<b>Solution Flow Rate</b>		<b>@ 40 PSI</b>	<b>@ 2.7 bar</b>
Foam		1.7 gpm	6.4 lpm
<b>Water Flow Rate</b>			
Rinse		7.2 gpm	27.3 lpm
<b>Discharge Hoses</b>			
ID			
Airless Foam		1/2 in.	12.7 mm
Rinse		3/4 in.	19.1 mm
Length		50 ft.	15.2 m

### Includes

- Machined polypropylene foamer body
- Stainless steel mounting enclosure
- Stainless steel ball valves
- Two discharge hose assemblies:
  - Rinse: White hose with stainless steel ball valve and Lafferty's 4-hole rinse nozzle
  - Foam: Blue hose with stainless steel ball valve and wand



Model #	Description
920918	Rinse / Pump Fed Airless Foam HDS



Airless foam discharge hose assembly



Rinse hose assembly with Lafferty's 4-hole rinse nozzle

# PUMP FED FOAM / FOAM / SANITIZE HOSE DROP STATION

REQUIRES: RTU CHEMICAL @ 35 - 125 PSI SOLUTION PRESSURE, COMPRESSED AIR



- For use with RTU chemical solution supplied by a central chemical feed system.
- Lafferty Foam / Foam / Sanitize Hose Drop Stations are convenient combination systems that will apply two chemical solutions as foam, and apply a third solution as a sanitizing spray.
- Medium volume output for all foaming applications.
- Usable foam throw distance of up to 12 ft. (3.7 m)
- Covers up to 500 ft<sup>2</sup> (46.5 m<sup>2</sup>) in 2 minutes

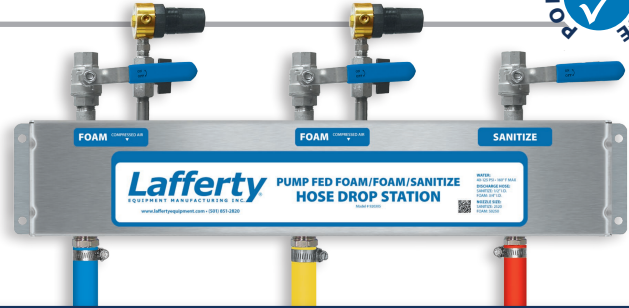

## REQUIREMENTS / SPECIFICATIONS

<b>Compressed Air</b>	<b>4 cfm</b>	<b>113.3 lpm</b>
<b>Solution Pressure</b>	<b>35 - 125 PSI</b>	<b>2.4 - 8.6 bar</b>
<b>Solution Flow Rate</b>	<b>@ 40 PSI</b>	<b>@ 2.7 bar</b>
Sanitize	1.7 gpm	6.4 lpm
Foam	1.7 gpm	6.4 lpm
<b>Discharge Hose</b>		
ID		
Sanitize	1/2 in.	12.7 mm
Foam	3/4 in.	19.1 mm
Length	50 ft.	15.2 m

### Includes

- Machined polypropylene foamer and sanitizer bodies
- Stainless steel mounting enclosure
- Stainless steel solution inlet ball valves
- Three discharge hose assemblies:
  - Foam: Red hose with stainless steel ball valve, polypropylene wand and fan nozzle
  - Foam: Blue hose with stainless steel ball valve, polypropylene wand and fan nozzle
  - Sanitize: Red hose with stainless steel ball valve, wand and fan nozzle

Model #	Description
920305	Pump Fed Foam / Foam / Sanitize HDS



*Upgrade Option for Unit listed above: Stainless Steel Foam Wand upgrade when ordering with unit. Request item # 536603-X.*

PUMP FED SINGLE-FUNCTION APPLICATORS

## PUMP FED SANITIZE / SANITIZE / FOAM HOSE DROP STATIONS

REQUIRES: RTU CHEMICAL @ 35 - 125 PSI SOLUTION PRESSURE + COMPRESSED AIR

- For use with RTU chemical solution supplied by a central chemical feed system
- Lafferty Sanitize / Sanitize / Foam Hose Drop Stations are convenient combination systems that will apply one chemical solution as foam, and two solutions as sanitizing sprays.
- Medium volume output for all foaming applications.
- Usable foam throw distance of up to 12 ft. (3.7 m)
- Covers up to 500 ft<sup>2</sup> (46.5 m<sup>2</sup>) in 2 minutes

### REQUIREMENTS / SPECIFICATIONS

<b>Compressed Air</b>	<b>4 cfm</b>	<b>113.3 lpm</b>
<b>Solution Pressure</b>	<b>35 - 125 PSI</b>	<b>2.4 - 8.6 bar</b>
<b>Solution Flow Rate</b>	<b>@ 40 PSI</b>	<b>@ 2.7 bar</b>
Sanitize	1.7 gpm	6.4 lpm
Foam	1.7 gpm	6.4 lpm
<b>Discharge Hose</b>		
ID		
Sanitize	1/2 in.	12.7 mm
Rinse & Foam	3/4 in.	19.1 mm
Length	50 ft.	15.2 m

### Includes

- Machined polypropylene foamer and sanitizer bodies
- Stainless steel mounting enclosure
- Stainless steel solution inlet ball valves
- Three discharge hose assemblies:
  - Sanitize: Red hose with stainless steel ball valve, wand and fan nozzle
  - Sanitize: Yellow hose with stainless steel ball valve, wand and fan nozzle
  - Foam: Blue hose with stainless steel ball valve, polypropylene wand and fan nozzle



Model #	Description
920303	Pump Fed Sanitize / Sanitize / Foam HDS



Sanitize discharge hose assemblies



Foam discharge hose assembly

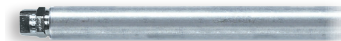

Upgrade Option for Unit listed above: Stainless Steel Foam Wand upgrade when ordering with unit. Request item # 536603-X.

## PUMP FED FOAM / RINSE / FOAM HOSE DROP STATION

REQUIRES: RTU CHEMICAL @ 35 - 125 PSI SOLUTION PRESSURE, RINSE WATER PRESSURE, COMPRESSED AIR

- For use with RTU chemical solution supplied by a central chemical feed system
- Lafferty Foam/Rinse/Foam Hose Drop Stations are convenient combination systems that will apply two different chemical solutions as foam, and rinse.
- Medium volume output for all foaming applications.
- Usable foam throw distance of up to 12 ft. (3.7 m)
- Covers up to 500 ft<sup>2</sup> (46.5 m<sup>2</sup>) in 2 minutes

### REQUIREMENTS / SPECIFICATIONS

<b>Compressed Air</b>	(up to)	<b>3 cfm</b>	<b>85.0 lpm</b>
<b>Solution /Water Pressure</b>		<b>35 - 125 PSI</b>	<b>2.4 - 8.6 bar</b>
<b>Solution Flow Rate</b>	<b>@ 40 PSI</b>	<b>@ 2.7 bar</b>	
Foam	1.7 gpm	6.4 lpm	
<b>Water Flow Rate</b>			
Rinse	7.2 gpm	27.3 lpm	
<b>Discharge Hoses</b>			
ID	3/4 in.	19.1 mm	
Length	50 ft.	15.2 m	

### Includes

- Machined polypropylene foamer bodies
- Stainless steel mounting enclosure and solution /water inlet ball valves
- Three discharge hose assemblies:
  - Rinse: White hose with stainless steel ball valve and Lafferty's machined stainless steel 4-hole rinse nozzle
  - Foam: Red hose with stainless steel ball valve, polypropylene wand and fan nozzle
  - Foam: Blue hose with stainless steel ball valve, polypropylene wand and fan nozzle



Model #	Description
920315	Pump Fed Foam/Rinse/Foam HDS



Rinse hose assembly with Lafferty's unique 4-hole stainless steel rinse nozzle



Foam discharge hose assemblies



Upgrade Option for Units listed this page: Stainless Steel Foam Wand upgrade when ordering with unit. Request item # 536603-X.

PUMP FED SINGLE-FUNCTION APPLICATORS



**LAFFERTY HIGH FLOW LEVEL MASTERS** are float-valve-operated proportioners, designed to quickly replenish and maintain the desired level of ready-to-use (RTU) chemical solution in any reservoir. A dual-float valve safety system triggers an air-activated solenoid to start and stop the flow of water through the high flow venturi proportioners and guards against overflow, if the primary float valve malfunctions.

High Flow Level Master Systems are available as integrated systems complete with 60-gallon tanks.

## HIGH FLOW LEVEL MASTER SYSTEMS

REQUIRES: 35-125 PSI WATER, COMPRESSED AIR AND CHEMICAL CONCENTRATE

- Float-valve-operated proportioners, designed to quickly replenish and maintain the desired level of ready-to-use (RTU) chemical solution in any reservoir.
- The float valve triggers an air-activated solenoid to start and stop the flow of water through the high volume venturi proportioners. *(Details featured below.)*
- Draws chemical concentrate from a user-supplied bulk container, dilutes the chemical to the required ratio and delivers the solution to the 60 gallon tank (or a user-supplied day tank)
- Choice of two flow rates. Replenishes RTU solution at:
  - 10.6 gpm @ 40 PSI – 989106  
*(Includes a single high flow venturi proportioner)*
  - 21.2 gpm @ 40 PSI – 989108  
*(Includes two high flow venturi proportioners)*
- Integrated system with 60-gallon tanks, complete with hook-up connections for a compressed air-operated Lafferty Pumping System (or a user-supplied pumping system)

### REQUIREMENTS / SPECIFICATIONS

<b>Compressed Air</b>	<1 cfm	<28.3 lpm
<b>Water Pressure</b>	35 - 125 PSI	2.4 - 8.6 bar
<b>Water Flow Rate</b>	@ 40 PSI	@ 2.8 bar
989106; 989100	10.6 gpm	40.1 lpm
989108; 989101	21.2 gpm	80.3 lpm

### Includes

- Auto on / off double-safety float valve, for continuous operation
- Manual on / off ball valve, for use when emptying solution reservoir
- Durable float with adjustable stainless steel float chain
- 60-gallon HDPE tank
- Color coded metering tips for up to 21 dilution ratios

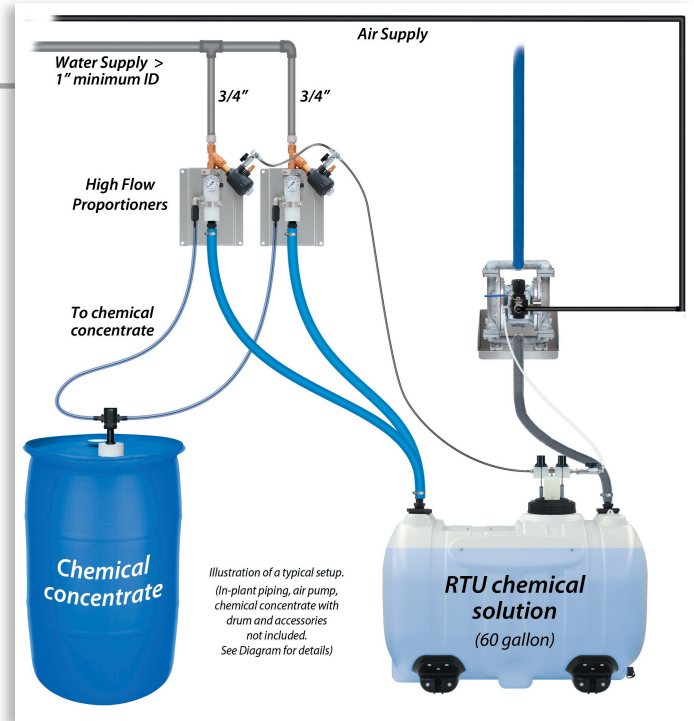

Model #	Description
989106	60 / 10 High Flow Level Master™
989108	60 / 20 High Flow Level Master™
989100	10 GPM High Flow Level Master (Customer Supplied Tank)
989101	20 GPM High Flow Level Master (Customer Supplied Tank)

## FEATURED: DUAL FLOAT AIR LEVEL MASTER LID

- The Dual Float Air Level Master Lid is included with High Flow and Gemini High Flow Level Master Systems to provide the highest degree of reliability and assurance against overflow due to float valve malfunction.

### Features:

- **Inlet Strainer** — This highly important component protects the system. Without it, small bits of debris can block the two hoses in the diaphragm and make it fail.
- **Two Unsinkable, Solid Polypropylene Floats**
- **Polypropylene Guide** — Keeps the floats hanging straight for smooth operation.
- **Solid CPVC "Push Rods"** — Unlike chains or Teflon sleeves, the rods will actually push up as liquid in the tank rises, assisting the float valve's operation and even helping force the valve magnet to move if it begins to stick.
- **Check Valve** — In line between the two float valves, the check valve prevents any chance of back flow when the second (safety) float valve activates to turn off the system.

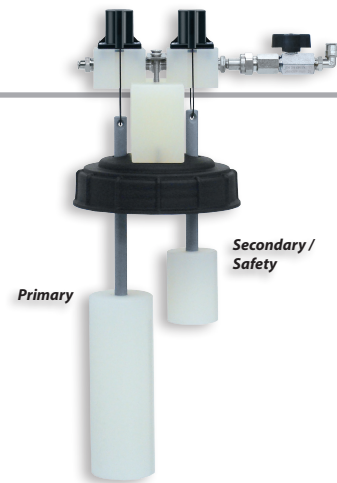



**LAFFERTY GEMINI™ HIGH FLOW LEVEL MASTERS™** feature two completely separated venturis in one injector body so that two chemical concentrates of differing or similar viscosities are diluted independently then blended in a single discharge stream. Level Masters are float-valve-operated proportioners, designed to quickly replenish and maintain the desired level of ready-to-use (RTU) chemical solution in any reservoir. A dual-float valve safety system triggers an air-activated solenoid to start and stop the flow of water through the high flow Gemini proportioner and guards against overflow, if the primary float valve malfunctions.

Gemini High Flow Level Master Systems are available as integrated systems complete with 60-gallon tanks.

## GEMINI HIGH FLOW LEVEL MASTER SYSTEMS

REQUIRES: 35-125 PSI WATER, COMPRESSED AIR AND TWO CHEMICAL CONCENTRATES

- Float-valve-operated proportioners, designed to quickly replenish and maintain the desired level of ready-to-use (RTU) chemical solution in any reservoir.
- The float valve triggers an air-activated solenoid to start and stop the flow of water through the high volume venturi proportioners. (Pictured below.)
- The unique twin pick-up Gemini High Flow Level Master System is an industry-leading design that incorporates two completely separated venturis in one injector body.
- Allows precise independent dilution of two chemicals with differing viscosities and dilution ratios
- Can be used for adding foaming or sanitizing agents
- The two chemical concentrates are drawn from user-supplied bulk containers, cannot cross mix and the diluted solutions mix only as they are discharged into the 60-gallon tank (or a user-supplied day tank).
- Choice of two flow rates. Replenishes RTU solution at:
  - 7.0 gpm @ 40 PSI – 989126 (Includes a single Gemini high flow venturi proportioner)
  - 14.0 gpm @ 40 PSI – 989128 (Includes two Gemini high flow venturi proportioners)
- Integrated system with 60-gallon tanks, complete with hook-up connections for a compressed air-operated Lafferty Pumping System (or a user-supplied pumping system)

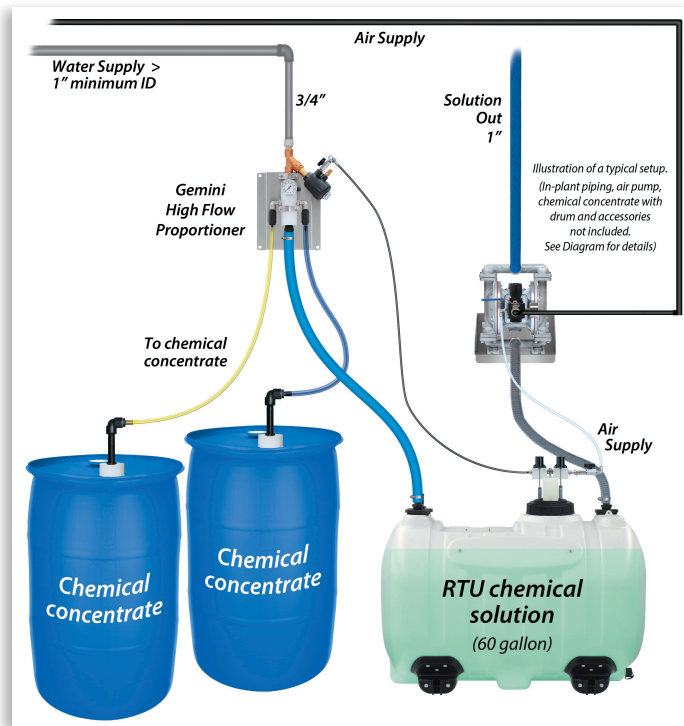

### REQUIREMENTS / SPECIFICATIONS

<b>Compressed Air</b>	<1 cfm	<28.3 lpm
<b>Water Pressure</b>	35 - 125 PSI	2.4 - 8.6 bar
<b>Water Flow Rate</b>	@ 40 PSI	@ 2.8 bar
989126; 989072	7.0 gpm	26.5 lpm
989128; 989074	14.0 gpm	53.0 lpm

#### Includes

- Auto on / off float valve, for continuous operation
- Manual on / off ball valve, for use when emptying solution reservoir
- Durable float with adjustable stainless steel float chain
- 60 gallon HDPE tank
- Color coded metering tips for up to 21 dilution ratios

A fail-safe secondary shutoff float valve provides overflow protection

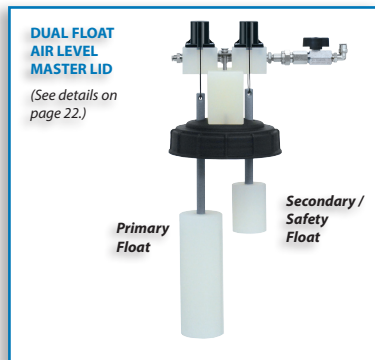

Model #	Description
989126	60 / 7 Gemini High Flow Level Master
989128	60 / 14 Gemini High Flow Level Master
989072	7 GPM Gemini Level Master (Customer Supplied Tank)
989074	14 GPM Gemini Level Master (Customer Supplied Tank)

DILUTION SYSTEMS



**LAFFERTY CENTRAL CHEMICAL FEED SYSTEMS** deliver diluted (Ready-to-use/"RTU") chemical solution to multiple Lafferty Pump Fed Foamers, Sanitizers or combination Hose Drop Stations. A compressed air operated double diaphragm (AODD) pump delivers the chemical solution to these units from a Lafferty High Flow Level Master System or from a holding tank.

## 1" CENTRAL PUMP SYSTEMS

REQUIRES: COMPRESSED AIR @ 65-100 PSI AND RTU CHEMICAL SOLUTION

- The air operated pump delivers diluted chemical to Lafferty pump fed sanitizers, foamers or combination hose drop stations from a Lafferty High Flow Level Master System or from a holding tank.
- Complete system mounted on a heavy duty stainless steel mounting bracket
- Heavy-duty metallic, 1" AODD pump with all stainless steel wetted components
- Two Models – Diaphragm material dependent on chemical used:

Santoprene diaphragm (919060SS)

Teflon diaphragm (919060SS-T)

REQUIREMENTS / SPECIFICATIONS

**Compressed Air** up to **35 cfm 991 lpm**  
**Solution Output** up to **25.0 gpm 94.6 lpm**  
 @ 65 PSI @ 4.1 bar

For higher flow rates and / or system redundancy, install multiple complete systems.

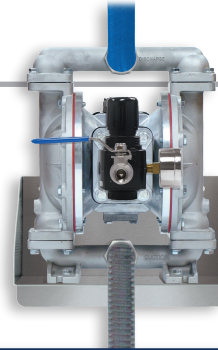

Model #	Description
<b>Up to 25 gallons per minute</b>	
919060SS	Central Pump System, Stainless Steel / Santoprene
710943	Teflon Diaphragm upgrade for 1" SS Air Pump

## 1/2" MINI-CENTRAL PUMP SYSTEM

REQUIRES: COMPRESSED AIR AND RTU CHEMICAL SOLUTION

- The air operated pump delivers diluted chemical to Lafferty pump fed sanitizers, foamers or combination hose drop stations from a Lafferty High Flow Level Master System or from a holding tank.
- Complete system mounted on a heavy duty stainless steel mounting bracket
- Polypropylene pump with Santoprene diaphragms
- Optional Teflon diaphragm available

REQUIREMENTS / SPECIFICATIONS

**Compressed Air** up to **16 cfm 453.1 lpm**  
**Solution Output** up to **9.0 gpm 34.1 lpm**  
 @ 65 PSI @ 4.1 bar

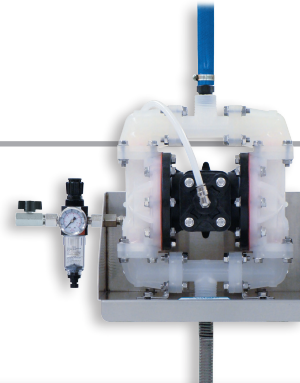

Model #	Description
<b>Up to 9 gallons per minute</b>	
919050	Mini-Central Pumping System
710919	Teflon Diaphragm Upgrade for 1/2" Air Pump

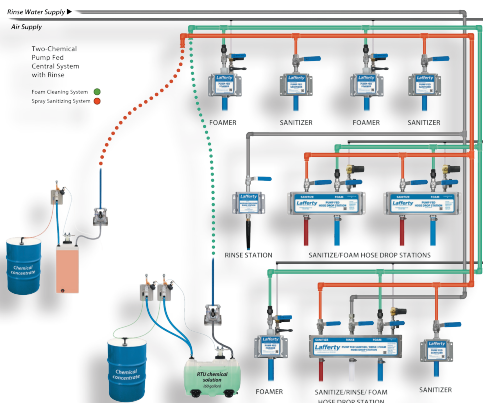

**Dilution Systems Planning**

- In a Central System, a pump system is required for each chemical solution to be supplied to pump fed applicators.
- The pump system for each solution must be sized to accommodate the total flow requirement of the pump fed applicators that will be in use at the same time.

*(See page 6 of this publication.)*

**Illustration:  
Twin High Flow Central Systems for Higher Volumes**

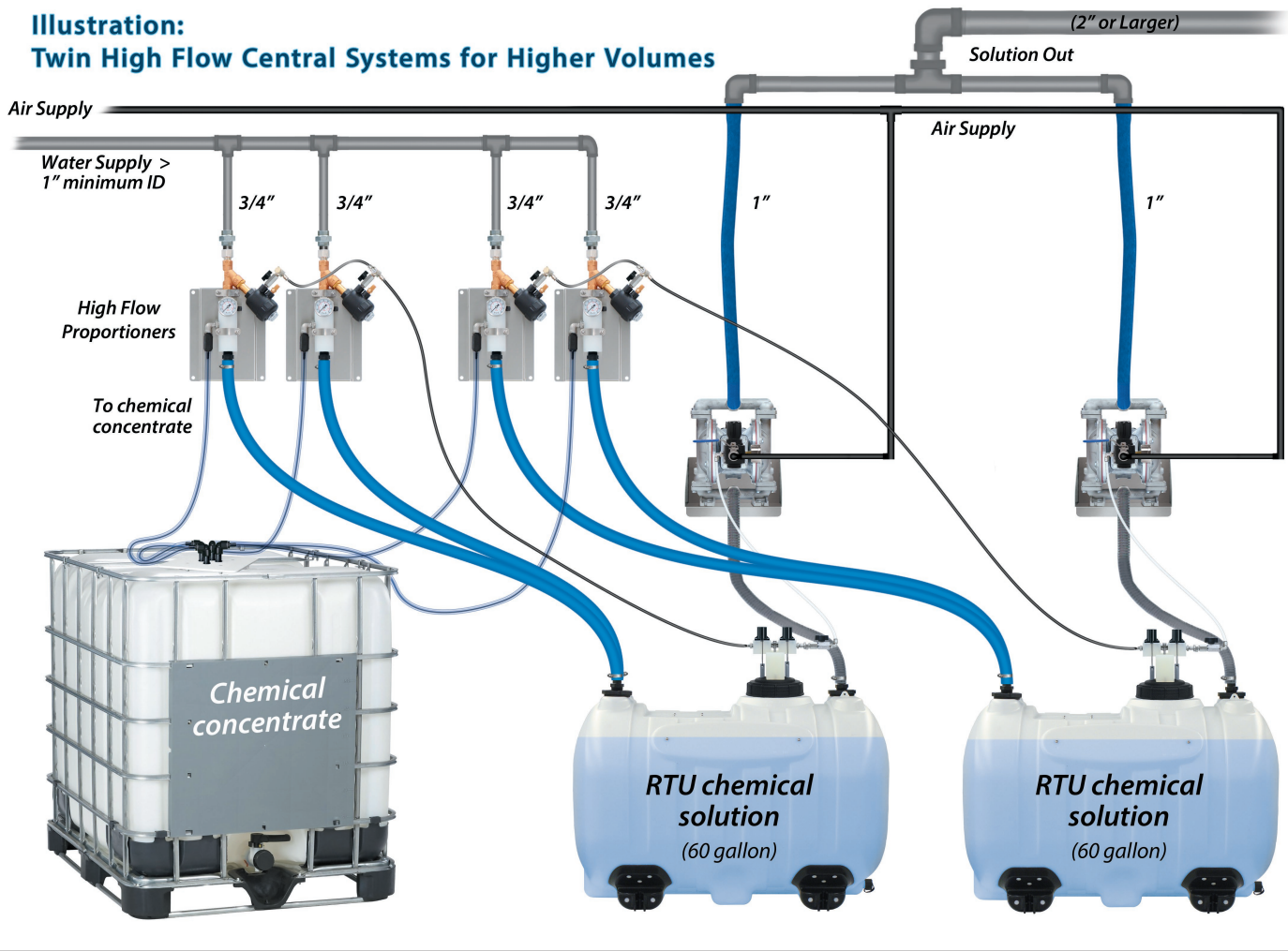

**SCALABILITY FOR CUSTOM NEEDS**

The components of Lafferty High Flow Central Systems are perfectly suited to be grouped in custom combinations to match the needs of large scale and growing operations. Whether you need greater capacity for a larger number of chemical applicators or fail-safe redundancy for critical operations, we can help you design the system that is just right for your operation.

**ACCESSORIES**

In addition to supplying parts for all Lafferty equipment, Lafferty offers a range of convenient accessories to complement its wide range of chemical application equipment.

Stainless steel hose racks and hose reels can be used with many products, while Drum Sticks and Tote Sticks offer a convenient way to draw chemical from bulk containers.

**STAINLESS STEEL HOSE RACKS**

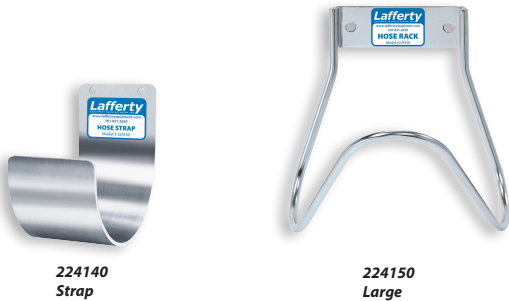

**HOSE CARRYING CAPACITY**

Model #		Inside Diameter x Length	
224140	Strap	1/2 in. ID up to 75 ft. (+/-)	12.7 mm ID x 22.9 m (+/-)
224150	Large	1 in. ID up to 75 ft. (+/-)	25.4 mm x 22.9 m (+/-)

Model #	Description
224140	Hose Strap, SS
224150	Hose Rack, SS, Large

**STAINLESS STEEL HOSE REEL**

- These retractable reels feature full-port swivels that allow unrestricted foam output. Other reels may have ports with narrowed openings through the swivel, which compresses the foam, resulting in watery, inferior foam output.
- Use with confidence with Lafferty pump fed sanitizers, foamers and rinse applicators that require 3/8", 1/2" or 3/4" ID hose

**Features**

- High Quality Electro-Polished Stainless Steel Construction
- Non-Corrosive Stainless Steel Fluid Path Featuring Stainless Steel Swivel
- Auto Rewind Easily Wraps, Stores and Protects Hose
- Guide Arm Adjusts To Wall, Floor and Overhead Positions
- Made In The U.S.A.

**REQUIREMENTS / SPECIFICATIONS**

<b>Water Pressure</b>	<b>up to</b>	<b>150 PSI</b>	<b>10.3 bar</b>
<b>Discharge Hose ID</b>	<b>either</b>	1/2 in.	12.7 mm
		3/4 in.	19.1 mm
<b>Water Pressure</b>	<b>up to</b>	<b>300 PSI</b>	<b>20.7 bar</b>
<b>Discharge Hose ID</b>	<b>either</b>	1/2 in.	12.7 mm
		3/8 in.	9.5 mm

**Includes:**

- 6' Lafferty-specified jumper hose (assures compatibility with Lafferty foamers and spray applicators)
- Heavy Gauge Steel/Stainless Steel Base and Support Post
- Stainless Steel Rollers
- Factory-Matched Cartridge-Style Spring Motor
- Multi-Position Lock Ratchet Secures Hose At Desired Length
- Rolled Edges and Ribbed Discs Provide Strength and Safety
- Leading 2-Year Manufacturer's Limited Warranty

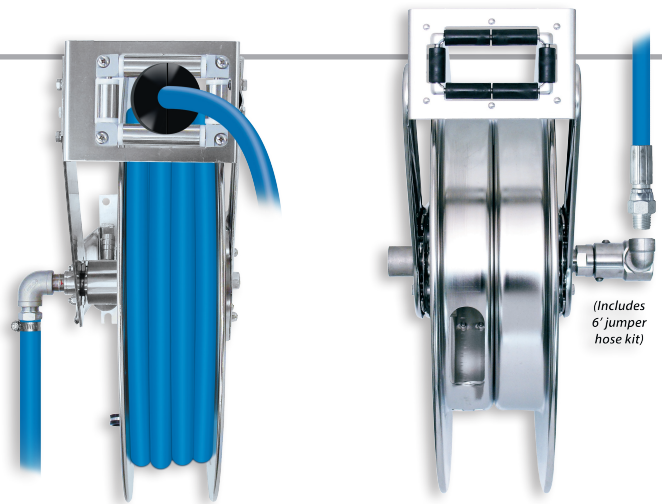

Model #	Description
224177-A <sup>†</sup>	Hose Reel, SS, 1/2" x 50', 150 PSI, w/Jumper Hose Kit <i>Suitable for all Pump Fed Sanitizer and Airless Foam Applicators</i>
224178-A <sup>†</sup>	Hose Reel, SS, 3/4" x 50', 150 PSI, w/Jumper Hose Kit <i>Suitable for all Pump Fed Foam Applicators (except 919305 – Pump Fed XV Foamer) and all City Water Pressure Rinse Applicators</i>
224183-A <sup>†</sup>	Hose Reel, SS, 3/8" x 75', 300 PSI, w/Jumper Hose Kit
224186-A <sup>†</sup>	Hose Reel, SS, 1/2" x 75', 300 PSI, w/Jumper Hose Kit <i>Suitable for Boosted Pressure Rinse Applicator #920135</i>

<sup>†</sup>Allow six weeks production time. Discharge hose and applicator wand not included.



**LAFFERTY DRUM STICKS™ AND TOTE STICKS™** are chemical pick-up assemblies for use with pump-operated or venturi systems to draw chemical concentrates or diluted chemical solution directly from a drum, tote or holding tank.

Choice of seal material for optimum chemical resistance.

Choice of lengths with custom lengths available.

## DRUM STICK / TOTE STICK

- Chemical/acid resistant polypropylene construction
- Connects to chemical pick-up tubes fitted to any venturi applicator or chemical pumping system
- Drum Bung Adaptor, machined to fit either coarse or fine-threaded bung holes, and Tote Stick Cover, for larger openings on totes and other bulk containers, keep trash out of chemical and allow easy depth adjustment of the Drum or Tote Stick.
- Rigid pipe overcomes problems common with flexible tubing
- Hastelloy strainer easily accessible for cleaning
- Choice of Viton or EPDM seals

### SPECIFICATIONS

#### Polypropylene extension pipe

ID	3/4 in.	19.1 mm
Lengths:	Pipe Length	Inside Drum/Tote
33" Drum Stick	33 in. / 0.83 m	35 in. / 0.89 m
48" Drum Stick	48 in. / 1.22 m	50 in. / 1.27 m
54" Drum Stick	54 in. / 1.37 m	56 in. / 1.42 m
33" Tote Stick	33 in. / 0.8 m	36 in. / 0.91 m
48" Tote Stick	48 in. / 1.22 m	51 in. / 1.29 m
54" Tote Stick	54 in. / 1.37 m	57 in. / 1.45 m

#### Includes

- Machined polypropylene Drum Bung Adaptor with coarse and fine threads or 11" x 11" polypropylene Tote Stick Cover
- Four polypropylene hose barbs:
 

1/4 in.	6.3 mm
3/8 in.	9.5 mm
1/2 in.	12.7 mm
3/4 in.	19.0 mm
- Polypropylene chemical check valve
- Hastelloy chemical strainer

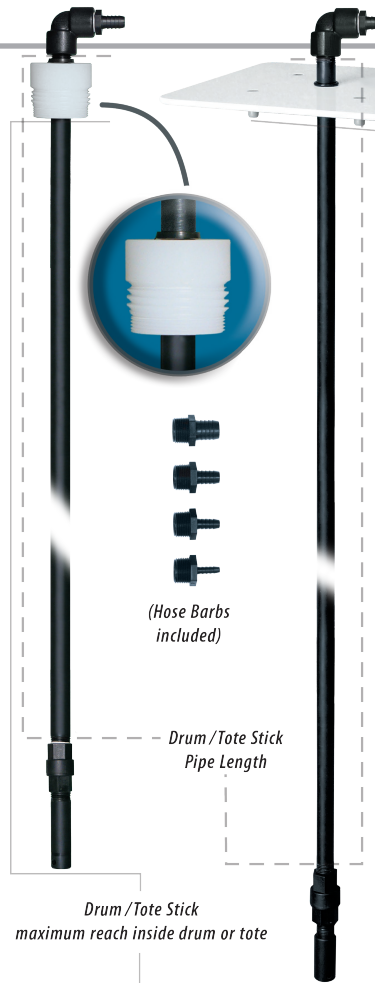

Model #	Description
491643	Drum Stick, 33" (Viton seals)
491643-E	Drum Stick, 33" (EPDM seals)
491644	4-Way Drum Stick, 33" (Viton seals)*
491644-E	4-Way Drum Stick, 33" (EPDM seals)*
491648	Drum Stick, 48" (Viton seals)
491648-E	Drum Stick, 48" (EPDM seals)
491649	4-Way Drum Stick, 48" (Viton seals)*
491645	Drum Stick, 54" (Viton seals)
491645-E	Drum Stick, 54" (EPDM seals)
491653	Tote Stick, 33" (Viton seals)
494653-E	Tote Stick, 33" (EPDM seals)
491654	Tote Stick, 48" (Viton seals)
491654-E	Tote Stick, 48" (EPDM seals)
491656	Tote Stick, 54" (Viton seals)
491656-E	Tote Stick, 54" (EPDM seals)

Custom lengths available on request

### Tote Stick with Low Level Switch – # 492222 (CONTACT US)

The Tote Stick with Low Level Switch facilitates high volume chemical dispensing from large tanks or totes. The dispensing side of the assembly rests on the bottom of the tank and the low level switch side adjusts to the desired alert level. When the liquid in the tank drops below this level, the switch sends a signal to a user-supplied alert mechanism — an audible alarm or strobe light, for example.

- Switch works with AC or DC electrical alert mechanisms (Electrical specifications available online)
- 20' electrical cord included
- Switch is protected inside a durable machined polypropylene housing
- 1" polypropylene pipe and hose barb
- Rigid pipe overcomes problems common with flexible tubing
- Hastelloy strainer — filters debris from chemical tank; easily accessible for cleaning

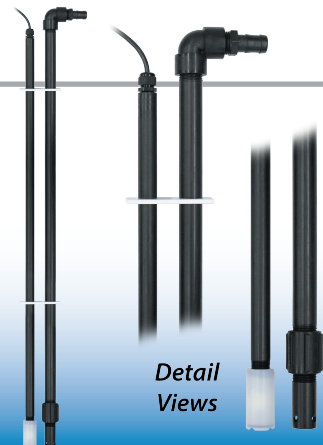

LAFFERTY CATALOG SERIES

• Food & Beverage Processing • Pharmaceutical • Agriculture • General Industrial Applications



1 • Venturi Systems – City Water Pressure

2 • Venturi Systems – Boosted Pressure

3 • Venturi Systems – High Pressure

4 • Compressed Air Operated Systems

5 • Pump Fed Sanitizers, Foamers & Hose Drop Stations

6 • Entryway, Drain & Hand Sanitizing Systems

7 • Foggers and Fogging Systems

Special Applications

8 • Asphalt Release, Acid / Corrosive & Solvent Systems

9 • Chemical Management Systems

10 • Vehicle Wash & Detailing Systems

11 • JanSan / Commercial / Residential Systems

12 • Supermarket / Deli / Small Area Cleaning Systems

