

**3 Venturi Systems -  
High Pressure**

- Spray-Alls
- Airless Foamers
- Air Assisted Foamers
- Airless Combination Applicators
- Air Assisted Combination Applicators
- Accessories



# Lafferty

EQUIPMENT MANUFACTURING LLC

**CATALOG 3**

**Venturi Systems  
High Pressure • 400 - 1000 PSI**

# Chemical Application Equipment

[www.LaffertyEquipment.com](http://www.LaffertyEquipment.com)

5614 Oak Grove Road • North Little Rock, AR 72118

Phone: 800-999-2820 / 501-851-2820 • Fax Orders: 800-699-3719

# Production and Environmental Sanitation Equipment

## Critical to Producing the Highest Quality Food Products

---

Regulations, public expectations and competitive pressures require business and industry to maintain clean production areas, machinery and equipment. In today's world, a bacterial or pathogenic food contamination scare can panic people or cripple industries half a world away. Companies that are serious about cleaning invest in the best chemicals and the best chemical application equipment.

Lafferty builds quality into every piece of chemical application equipment – from the precision machining of our sanitizer and foamer bodies, to the careful selection of heavy-duty components, to the individual testing of every unit. This keeps Lafferty Equipment products working better and longer than any other brand.

Once you experience Lafferty quality and performance, you will know that no other brand can be "just like a Lafferty."

## Venturi Technology Perfected

---

Lafferty Equipment's business is founded on venturi technology. For nearly 40 years, we at Lafferty have been perfecting our product offering through rigorous attention to venturi design and the manufacture of balanced systems, engineered to meet the needs of our customers.

The beauty of using a venturi for chemical application is the simplicity; there are no moving or wearing parts. Lafferty venturis are machined from chemical-resistant, solid, thermoplastics or stainless steel, to ensure long product life despite heavy, daily use or harsh environmental conditions.

### **Translating venturi theory into superior performance is the essence of "The Lafferty Difference"**

Lafferty has developed an extensive range of venturi sanitizers and foamers that are designed to suit a wide variety of generalized and specialized applications at locations with high pressure water systems.

Most Lafferty venturi systems come equipped with 20 different sized metering tips, which are used to control chemical dilution ratios.

Dilution ratios can be set by selecting the appropriate metering tip, using the chart contained in the operating instructions.

## Lafferty's Complete Balanced System Approach

The team at Lafferty Equipment puts more than a century of combined manufacturing and in-the-field experience into the equipment that we offer. Our approach is to provide a complete, balanced system right out of the box for ease of installation and trouble-free performance.

Lafferty Equipment's core product offering is the widest range of chemical application equipment available in the marketplace.

If a standard product does not meet the need, we have many specialized systems not listed in this catalog, which may provide the solution. If not, we will work with you to create a system to meet the client's specific requirements.

Our passionate focus on superior quality, outstanding reliability and attention to detail ensures years of consistent operational performance and peace of mind.

### Focus on Performance

- Dedicated Research and Development team
- Application-specific designs to create integrated balanced systems
- Discharge hoses (lengths and diameters), wands and nozzles carefully selected to ensure optimum system performance
- Machined sanitizer and foamer bodies engineered for their specific, intended use
- Reliable, precision metering options

### Focus on Quality, Reliability and Durability

- Designed to endure heavy usage in industrial settings with minimal maintenance requirements
- Lafferty's proprietary stainless steel and polypropylene components are precision machined on state-of-the-art CNC and traditional machine tools in Lafferty's manufacturing facility in Arkansas.
- Extensive testing of all finished products
- Material selected for optimum chemical and industry compatibility, with all wetted parts chemically resistant
- Stainless steel mounting enclosures for industrial settings

### Focus on Service

- Dedicated to superior customer service and support
- Prompt order shipment
- Detailed web site and catalog information for equipment selection
- Comprehensive Installation and Operation Instructions

# High Pressure

Lafferty High Pressure Chemical Applicators are designed for use in food and beverage processing facilities equipped with a pressurized water system operating between 400 and 1,000 PSI or 2,000 PSI, depending on the applicator model.

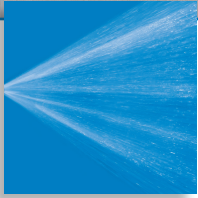

**LAFFERTY HIGH PRESSURE SANITIZER / SPRAY-ALLS™** are water-driven venturi systems that accurately dilute chemical concentrates to required ratios and spray the solution onto any surface. The supplied fan nozzle provides for quick area coverage with a medium spray.

Wall mount units offered with Lafferty's signature heavy duty stainless steel mounting enclosures and portable models feature heavy duty stainless steel carts.

## SANITIZER / SPRAY-ALLS

REQUIRES: 400-1000 PSI WATER

- For use with high pressure water systems, the Lafferty Spray-All accurately dilutes chemical concentrates and produces medium spray
- Equipping the sprayer / sanitizer with a rollover nozzle assembly adds the convenience of alternating between spraying and rinsing at the hose end without having to return to the wall mounted unit.
- Choice of two flow rates.

### REQUIREMENTS / SPECIFICATIONS

<b>Water Pressure</b>	<b>400 - 1000 PSI</b>	<b>27.6 - 69 bar</b>
<b>Water Flow Rate</b>	<b>@ 700 PSI</b>	<b>@ 48.3 bar</b>
W-10SS	1.9 gpm	7.2 lpm
W-20SS - Spray/Sanitize	3.1 gpm	11.7 lpm
Rinse (918056)	5.0 gpm	18.9 lpm
<b>Discharge Hose</b>		
ID	3/8 in.	9.5 mm
Length	50 ft.	15.2 m

### Includes

- Machined stainless steel injector body
- Stainless steel mounting enclosure
- Color-coded metering tips (20)
- Metering tip holder
- High pressure discharge hose with trigger gun, stainless steel wand and matching fan nozzle
- Chemical / rinse rollover nozzle assembly (918056)
- Portable models feature all stainless steel carts

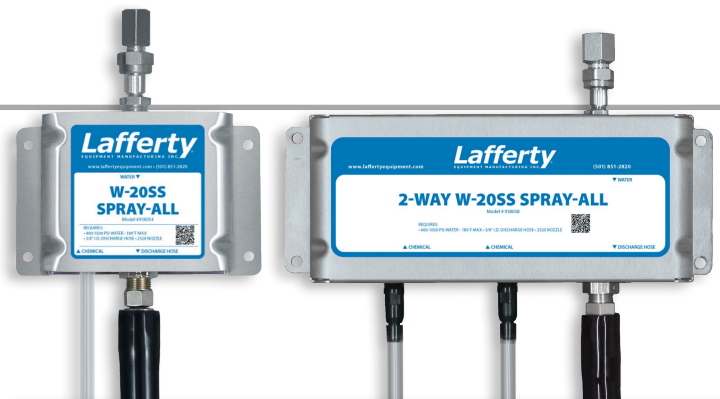

Model #	Description
918050	W10SS Spray-All
918054	W-20SS Spray-All
918056	W-20SS Spray-All w/Rollover Nozzle
918058	2-Way W-20SS Spray-All
918954	Portable 5 Gallon W-20SS Spray-All
<b>Option</b>	
536500	Insulator For 1/4" SS Wand



**EASY TRIGGER GUN**  
Requires half the effort of other guns. Easy-pull trigger and comfortable grip provide ease when working long hours.





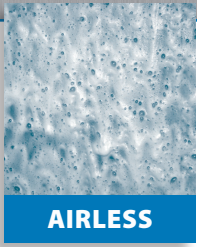

**AIRLESS**

**LAFFERTY STAINLESS STEEL HOSE END AIRLESS FOAMERS AND COMPACT AIRLESS FOAMERS** are machined stainless steel venturis that quick connect to a high pressure trigger gun and draw chemical and air to create clinging wet foam. Can apply more aggressive chemicals since no chemical passes through the hose or trigger gun.

These rugged foamers come with everything needed for injecting chemicals using a high pressure water outlet — quick connect fittings, metering tips and clear tubing with strainer or 32 oz. chemical bottle.

## STAINLESS STEEL HOSE END AIRLESS FOAMERS AND COMPACT FOAMERS

REQUIRES: 1000 PSI WATER (MINIMUM), CHEMICAL CONCENTRATE

- Draw chemical concentrate from any chemical container and dilute it to the required ratio.
- Foam is created instantly by the stainless steel venturi airless foam wand
- Two foam nozzles: Fan nozzle for quick coverage, up close; zero degree for added distance
- Quickly change from foaming to rinsing.
- Foam throw up to 25 ft. (up to 20 ft. for HC models)
- HC model for high concentrate solutions up to a strong 3.5:1
- Choice of two Hose End models and one Compact model

### REQUIREMENTS / SPECIFICATIONS

Water Flow Rate	minimum	1000 PSI	68.9 bar
Model 20	2.2–5.5 gpm		8.3–20.8 lpm

#### Includes:

- All stainless steel construction: Foamer body, quick connect plug, airless foam wand and nozzles
- Fan and 0° foam nozzles
- 32 oz. heavy duty, wide-mouth HDPE bottle (969621-B)
- Color coded metering tips for up to 21 dilution ratios
- Metering tip driver



HC = High Concentrate unit for up to 3.5:1 dilution ratio

Model #	Description
969620	Model 20 SS Hose End Airless Foamer
969620HC	Model 20 SS HC Hose End Airless Foamer



Model #	Description
969621-B	Model 20 SS Compact Airless Foamer

### Lid Color Options for Stainless Steel Compact Foamers & Sprayers



### Safe Flow Lids™ for 1 Gallon Jugs and 5 Gallon Pails

FOR USE WITH HOSE END AIRLESS FOAMERS AND SPRAYERS

- Machined polypropylene lid; Threads fit 1 gallon jugs and the pull-up spout of many 5 gallon jugs
- Safe and Convenient — Prevents chemical splashing; Allows quick replacement of concentrate
- Includes tube barbs and attached suction tube

Model #	Description
709101	Safe Flow Lids™ for 1 Gallon Jugs and 5 Gallon Pails

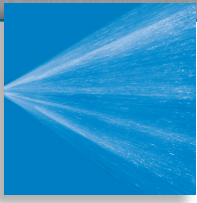

**LAFFERTY STAINLESS STEEL HOSE END AIRLESS SPRAYERS AND COMPACT SPRAYERS** are machined stainless steel venturis that quick connect to a high pressure trigger gun and draw chemical and air to create a chemical spray. Can apply more aggressive chemicals since no chemical passes through the hose or trigger gun.

These rugged sprayers come with everything needed for injecting chemicals using a high pressure water outlet — quick connect fittings, metering tips and clear tubing with strainer or 32 oz. chemical bottle.

## STAINLESS STEEL HOSE END SPRAYERS AND COMPACT SPRAYERS

REQUIRES: 2.2 TO 6 GPM PRESSURE WASHER, CHEMICAL CONCENTRATE

- Draw chemical concentrate from any chemical container (Hose End models) or from the attached 32 oz. bottle (Compact model) and dilute it to the required ratio.
- Fan pattern for quick coverage close up, remove the nozzle for distance
- Quickly change from spraying to rinsing.

### REQUIREMENTS / SPECIFICATIONS

**Water Flow Rate** *minimum* **1000 PSI** **68.9 bar**  
 Model 20 2.2–5.5 gpm 8.3–20.8 lpm

#### Includes:

- All stainless steel construction: Injector, quick connect plug and nozzle
- Fan spray nozzle
- 32 oz. heavy duty, wide-mouth HDPE bottle (969521-B)
- Color coded metering tips for up to 21 dilution ratios
- Metering tip driver

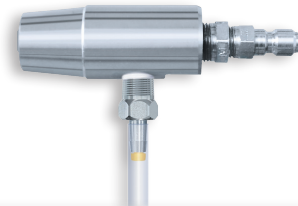

Model #	Description
969520	Model 20 SS Hose End Sprayer



Model #	Description
969521-B	Model 20 SS Compact Sprayer

Lid Color Options for Stainless Steel Compact Foamers & Sprayers



### Safe Flow Lids™ for 1 Gallon Jugs and 5 Gallon Pails

FOR USE WITH HOSE END AIRLESS FOAMERS AND SPRAYERS

- Machined polypropylene lid; Threads fit 1 gallon jugs and the pull-up spout of many 5 gallon jugs
- Safe and Convenient — Prevents chemical splashing; Allows quick replacement of concentrate
- Includes tube barbs and attached suction tube

Model #	Description
709101	Safe Flow Lids™ for 1 Gallon Jugs and 5 Gallon Pails

HIGH PRESSURE

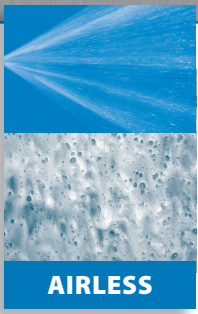

**LAFFERTY COMBO AIRLESS FOAMER/SPRAYER KITS** are machined stainless steel venturi injectors that quick connect to a high pressure water outlet and include a venturi foam wand and a spray nozzle that quick connect to a trigger gun. The injector draws chemical concentrate from any chemical container and dilutes it to the required ratio.

These kits come with everything needed for injecting chemicals using a high pressure water outlet — metering tips, quick connect fittings, clear tubing, and strainer.

## STAINLESS STEEL COMBO AIRLESS FOAMER/SPRAYER KITS

REQUIRES: 1000 PSI WATER (MINIMUM) AND CHEMICAL CONCENTRATE

- Draw chemical concentrate from any chemical container and dilute it to the required ratio.
- The stainless steel airless foam wand instantly creates wet clinging foam.
- Two foam nozzles: Fan nozzle for quick coverage, up close; zero degree for added distance
- The stainless steel spray nozzle applies non-foaming chemicals.
- **Model 10:** Foam throw up to 20 ft.
- **Model 20:** Foam throw up to 25 ft. (up to 18 ft. for HC models)
- HC model for high concentrate solutions, especially roof cleaning @ 5:1 and 9:1 dilution ratios @ 3.5-4.0 GPM.

### REQUIREMENTS / SPECIFICATIONS

Water Flow Rate	minimum	1000 PSI	68.9 bar
Model 10		2.2 to 3.4 gpm	8.3 to 12.9 lpm
Model 20		3.5-5.5 gpm	13.2-20.8 lpm

#### Includes:

- All stainless steel construction: Injector, quick connect plugs and socket, airless foam wand and nozzles
- Fan and 0° foam nozzles and fan spray nozzle
- Color coded metering tips for up to 21 dilution ratios and tip driver

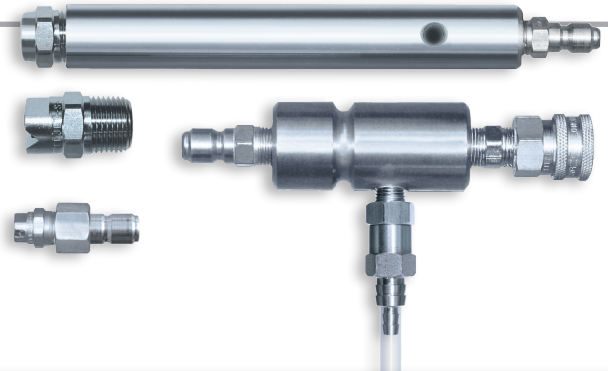

Model #	Description
969710	Model 10 SS Combo Airless Foamer/ Sprayer Kit
969720	Model 20 SS Combo Airless Foamer/ Sprayer Kit
969720HC*	Model 20 SS HC Combo Airless Foamer/ Sprayer Kit
<b>Optional Jug Lid with Suction Tube</b> (See page 26 for details.)	
709101	Safe Flow Lids™ for 1 Gallon Jugs and 5 Gallon Pails
807069	3/8" x 50' HP Hose, HP Trigger Gun and 1/4" QD Socket

\*HC (High Concentrate)



### Safe Flow Lids™ for 1 Gallon Jugs and 5 Gallon Pails

FOR USE WITH HOSE END AIRLESS FOAMERS AND SPRAYERS

- Machined polypropylene lid – Threads fit 1 gallon jugs and the pull-up spout of many 5 gallon jugs
- Safe and Convenient — Prevents chemical splashing; Allows quick replacement of concentrate
- Incorporated barb attaches directly to suction tube of Lafferty Hose End Sprayer or Airless Foamer
- Includes attached suction tube



Model #	Description
709101	Safe Flow Lids™ for 1 Gallon Jugs and 5 Gallon Pails

**AIR ASSISTED**

**LAFFERTY HIGH PRESSURE FOAMERS** are water-driven venturi systems that accurately dilute chemical concentrates to required ratios and project high quality foam onto any surface, providing for superior cleaning and visual assurance of complete coverage. A range of foam volumes and throw distances are available and the optimum model to use will be determined by the application and desired coverage speed.

Wall mount models offered with Lafferty's signature heavy duty stainless steel mounting enclosures and portable models feature heavy duty stainless steel carts.

**HP FOAMERS**

REQUIRES: 400-1000 PSI WATER, COMPRESSED AIR

- Lafferty HP air assisted foamers offer medium volume foaming capabilities for all foaming applications where high pressure water is available.
- Foam throw distance of up to 13 feet with included fan nozzle — Optional 0° nozzle available for greater foam throw distances.
- Covers up to 500 ft<sup>2</sup> (46.5 m<sup>2</sup>) in 2 minutes
- Stainless steel model (HPSS) for use at higher temperatures and pressures
- 2-Way HPSS Foamer includes two chemical suction tubes with ball valves to allow alternating between two different chemicals and/or dilution ratios.

**REQUIREMENTS / SPECIFICATIONS**

<b>Compressed Air</b>	(up to)	<b>5 cfm</b>	<b>141.6 lpm</b>
<b>Water Pressure</b>			
HP		<b>400- 700 PSI</b>	<b>27.6- 48.3 bar</b>
HPSS		<b>400- 1000 PSI</b>	<b>27.6- 69.0 bar</b>
<b>Water Flow Rate</b>			
		<b>@ 700 PSI</b>	<b>@ 48.3 bar</b>
		2.0 gpm	7.6 lpm
<b>Discharge Hose</b>			
ID		1/2 in.	12.7 mm
Length		50 ft.	15.2 m

**Includes**

- Machined polypropylene or stainless steel foamer body
- Stainless steel mounting enclosure
- Lock Box units include fully-enclosed, lockable stainless steel box
- Color-coded metering tips (20)
- Metering tip driver
- Discharge hose, open flow foam wand and matching nozzle



918805



918805DU

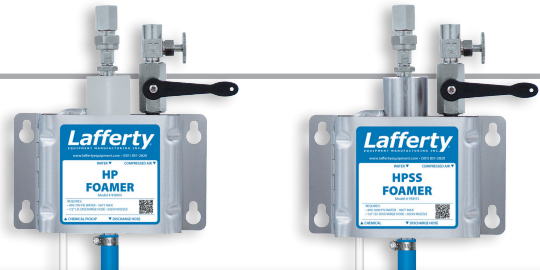

Model #	Description
918105	HP Foamer
918115	HPSS Foamer
918115-LB	Lock Box HPSS Foamer
918115DU	HPSS DU* Foamer
918805	Portable 5 Gallon HPSS Foamer
918805DU	Portable Dual 5 Gallon HPSS DU Foamer

\* DU indicates Dual chemical pickups for adding a foaming agent or drawing two compatible chemicals at once

Higher pressures can be accommodated. Contact us for details.

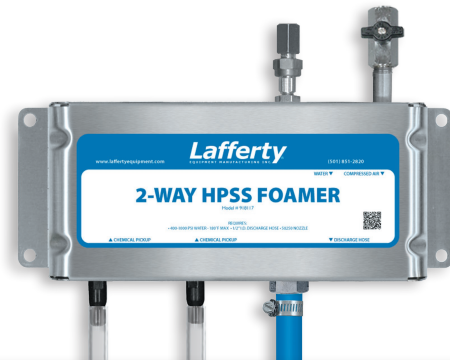

Model #	Description
918117	2-Way HPSS Foamer Complete
918117-LB	Lock Box 2-Way HPSS Foamer



Open flow polypropylene foam wand and matching fan nozzle

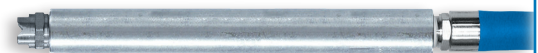

Upgrade Option for Units listed this page: Stainless Steel Wand upgrade when ordering with unit. Request item # 536603-X.

HIGH PRESSURE

## HYPER FOAMERS

REQUIRES: 400-1000 PSI WATER, COMPRESSED AIR

- Lafferty Hyper air assisted foamers offer fast foaming capabilities for all foaming applications where high pressure water is available
- Foam throw distance of up to 13 feet with included fan nozzle — Optional 0° nozzle available for greater foam throw distance.
- Covers up to 500 ft<sup>2</sup> (46.5 m<sup>2</sup>) in 1½ minutes

### REQUIREMENTS / SPECIFICATIONS

<b>Compressed Air</b>	(up to)	<b>5 cfm</b>	<b>141.6 lpm</b>
<b>Water Pressure</b>			
Hyper		<b>400 - 700 PSI</b>	<b>27.6 - 48.3 bar</b>
Hyper SS		<b>400 - 1000 PSI</b>	<b>27.6 - 69.0 bar</b>
<b>Water Flow Rate</b>			
		<b>@ 700 PSI</b>	<b>@ 48.3 bar</b>
		3.3 gpm	12.5 lpm
<b>Discharge Hose</b>			
ID		3/4 in.	19.1 mm
Length		50 ft.	15.2 m
Portable		40 ft.	12.2 m

### Includes

- Stainless steel base and cover
- Machined polypropylene or stainless steel foamer body
- Color-coded metering tips (20)
- Metering tip driver
- Discharge hose, open flow foam wand and matching fan nozzle. (0° nozzle optional)
- Draw chemical concentrate from any chemical container and dilute it to the required ratio.
- Portable models feature all stainless steel carts.

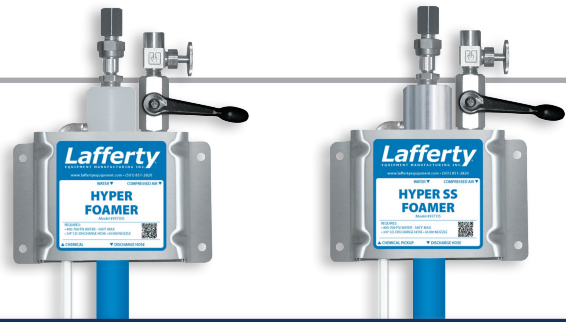

Model #	Description
917105	Hyper Foamer
917115	Hyper SS Foamer
917115DU	Hyper SS DU Foamer
917805	Portable 5 Gallon Hyper SS Foamer

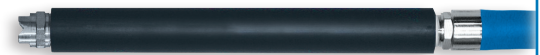

Open flow polypropylene foam wand and matching fan nozzle



917805

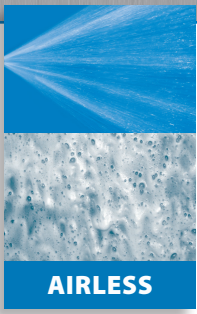

**LAFFERTY HIGH PRESSURE AIRLESS HOSE DROP STATIONS** are convenient combination systems that will apply one or two chemicals — as spray or airless foam — and rinse. Hose Drop Stations are water-driven venturi systems that accurately dilute chemical concentrates to required ratios and project a spray or high quality foam onto any surface.

Offered with Lafferty's signature heavy duty stainless steel mounting enclosures.

## RINSE / AIRLESS FOAM HOSE DROP STATION

REQUIRES: 400-1000 PSI WATER

- For use with high pressure water systems
- The Rinse / Airless Foam Hose Drop Station is a convenient combination system that will apply airless foam and rinse.
- Lafferty Airless Foamers do not require compressed air, eliminating cost and equipment adjustment issues.
- Foam is created instantly by the venturi airless foam wand.
- Foam throw distance up to 10 ft. with fan nozzle; up to 12 ft. with 0° nozzle

### REQUIREMENTS / SPECIFICATIONS

<b>Water Pressure</b>	<b>400 - 1000 PSI</b>	<b>27.6 - 68.9 bar</b>
<b>Water Flow Rate</b>	<b>@ 700 PSI</b>	<b>@ 48.3 bar</b>
A-20SS Airless Foam	3.1 gpm	11.7 lpm
Rinse	5.0 gpm	18.9 lpm
<b>Discharge Hose</b>		
ID	3/8 in.	9.5 mm
Length	50 ft.	15.2 m

### Includes

- Machined stainless steel injector body
- Stainless steel mounting enclosure
- Stainless steel ball valves
- Color-coded metering tips (20)
- Metering tip driver
- Two discharge hose assemblies:

**Foam:** High pressure hose, trigger gun, stainless steel airless foam wand with fan and 0° nozzles

**Rinse:** High pressure hose, trigger gun, stainless steel wand and matching fan nozzle



Model #	Description
917918	Rinse / A-20SS Airless Foam HDS
<b>Option</b>	
536500	Insulator For 1/4" SS Wand



Trigger gun, wand and matching fan nozzle.

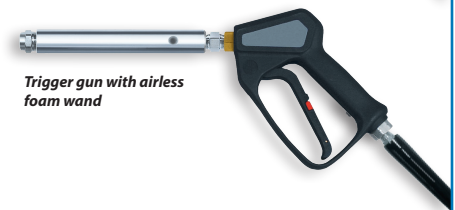

Trigger gun with airless foam wand

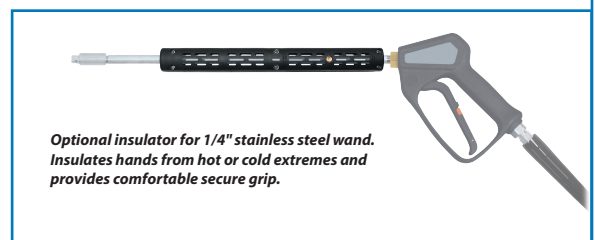

Optional insulator for 1/4" stainless steel wand. Insulates hands from hot or cold extremes and provides comfortable secure grip.

HIGH PRESSURE

# SANITIZE / AIRLESS FOAM HOSE DROP STATIONS AND SANITIZE / RINSE / AIRLESS FOAM HOSE DROP STATIONS

REQUIRES: 400-1000 PSI WATER

- These Lafferty stainless steel hose drop stations are convenient combination systems. Sanitize / Airless Foam Hose Drop Stations will apply one chemical as foam and a second chemical as a sanitizing spray. Sanitize / Rinse / Airless Foam Hose Drop Stations also rinse.
- The Lafferty W-20SS Sanitizer produces a medium spray.
- Lafferty Airless Foamers do not require compressed air, eliminating cost and equipment adjustment issues.
- Foam is created instantly by the venturi airless foam wand.
- Foam throw distance up to 10 ft. with fan nozzle; up to 12 ft. with 0° nozzle

## REQUIREMENTS / SPECIFICATIONS

**Water Pressure**                      **400 - 1000 PSI**    **27.6 - 68.9 bar**

**Water Flow Rate**                    **@ 700 PSI**        **@ 48.3 bar**

Sanitize	3.1 gpm	12.5 lpm
A-20SS Airless Foam	3.1 gpm	11.7 lpm
Rinse	8.4 gpm	31.8 lpm

### Discharge Hose

ID	3/8 in.	9.5 mm
Length	50 ft.	15.2 m

### Includes

- Machined stainless steel injector bodies
- Stainless steel mounting enclosure
- Stainless steel ball valves
- Color-coded metering tips (20)
- Metering tip driver
- Two discharge hose assemblies:
  - Sanitize: High pressure hose, trigger gun, stainless steel wand and matching fan nozzle
  - Foam: High pressure hose, trigger gun, stainless steel airless foam wand with fan and 0° nozzles
- Portable models feature all stainless steel carts



Model #	Description
917920	W-20SS Sanitize / A-20SS Airless Foam HDS
917942	Portable W-20SS Sanitize / A-20SS Airless Foam HDS
917927	W-20SS Sanitize / Rinse / A-20SS Airless Foam HDS
<b>Option</b>	
536500	Insulator For 1/4" SS Wand



Trigger gun, wand and matching fan nozzle.

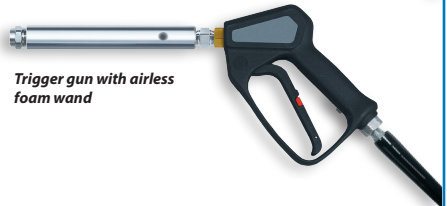

Trigger gun with airless foam wand



Optional insulator for 1/4" stainless steel wand. Insulates hands from hot or cold extremes and provides comfortable, secure grip.



**LAFFERTY TGSS FOAM APPLICATORS** feature trigger gun control of compressed air foam application using high pressure water. The TGSS Foamer is offered as a stand-alone unit and also comes incorporated into three styles of hose drop stations — Rinse/Foam; Sanitize/Foam; and Sanitize/Rinse/Foam — that use a second trigger gun with spray nozzle for sanitize and/or rinse applications.

TGSS Foamers are water-driven venturi systems that accurately dilute chemical concentrates to required ratios and project a high quality foam onto any surface.

Offered with Lafferty's signature heavy duty stainless steel mounting enclosures.

## TGSS FOAMERS AND HOSE DROP STATIONS

REQUIRES: 400-1000 PSI WATER, COMPRESSED AIR

- TGSS Foamers draw and blend chemical concentrate into the water stream to create an accurately diluted solution that is converted to rich, clinging foam by injecting compressed air into the solution to greatly increase volume and coverage ability. The foam is then projected through the discharge hose, trigger gun, and fan nozzle at distances up to 10 feet.
- TGSS Hose Drop Stations feature the TGSS Foamer and either the Lafferty W-20SS Sanitizer or a rinse function or both.
- The Lafferty W-20SS Sanitizer produces a medium volume spray.
- Stainless steel foamer body for durability and maximum chemical resistance
- Trigger gun discharge allows the user to start and stop foaming with ease
- Trigger gun, if dropped, shuts off automatically to enhance safety
- Projects rich, clinging foam which increases chemical contact time and effectiveness
- Foaming expands the chemical and reduces over-application by providing visual assurance of coverage
- Fan pattern nozzle for quick coverage (up to 10' range)
- Foamer covers up to 500 sq ft (46.5 sq m) in 4 minutes
- Adjustable foam consistency (wet/dry)
- Chemical resistant wetted components ensure years of outstanding performance with minimal maintenance

### REQUIREMENTS / SPECIFICATIONS

**Water Pressure**      **400- 1000 PSI**    **27.6-68.9 bar**

**Water Flow Rate**      **@ 700 PSI**      **@ 48.3 bar**

TGSS Foamer              0.9 GPM          lpm

W-20SS Sanitizer        3.1 GPM          lpm

Rinse                        8.4 GPM          lpm

### Discharge Hose

ID                            3/8 in.            9.5 mm

Length                     50 ft.             15.2 m

### Includes

- Stainless steel mounting bracket
- Stainless steel inlet ball valves (*air only on 918101*)
- Machined stainless steel foamer and/or sanitizer bodies
- 20 color-coded precision metering tips to set dilution ratios
- Quick connect fittings for connecting hose(s) to unit
- 50' foam hose with foaming trigger gun and fan nozzle
- 50' rinse/sanitize hose with trigger gun, wand and fan nozzle (*with hose drop stations*)

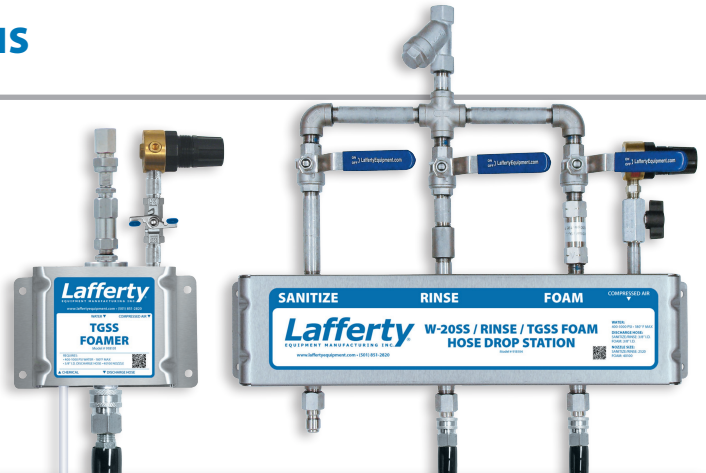

Model #	Description
918101	TGSS Foamer
918102	Rinse / TGSS Foam Hose Drop Station
918103	W-20SS Sanitize / TGSS Foam HDS
918104	W-20SS Sanitize / Rinse / TGSS Foam HDS
<b>Option</b>	
536500	Insulator For 1/4" SS Wand

HIGH PRESSURE



TGSS Foam trigger gun, wand and matching fan nozzle.

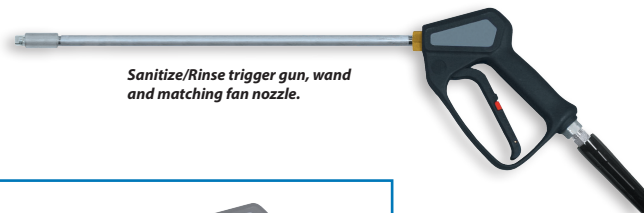

Sanitize/Rinse trigger gun, wand and matching fan nozzle.



Optional insulator for 1/4" stainless steel wand. Insulates hands from hot or cold extremes and provides comfortable, secure grip.



**LAFFERTY HIGH PRESSURE HOSE DROP STATIONS** are convenient combination systems offered as Rinse / Foam, Sanitize / Foam, and Sanitize / Rinse / Foam configurations.

Lafferty Hose Drop Stations are water-driven, air-assisted venturi systems that accurately dilute chemical concentrates to required ratios and project a spray or high quality foam onto any surface.

Offered with Lafferty's signature heavy duty stainless steel mounting enclosures.

## RINSE / FOAM HOSE DROP STATIONS

REQUIRES: 400-1000 / 2000 PSI WATER, COMPRESSED AIR

- For use with high pressure water systems, Lafferty stainless steel Rinse / Foam Hose Drop Stations are convenient combination systems that will apply foam and rinse.
- Choice of two foaming volumes.
- Foam throw distance of up to 13 ft. with included fan nozzle — Optional 0° nozzle available for greater foam throw distance.
- Covers up to 500 ft<sup>2</sup> (46.5m<sup>2</sup>) in 2 minutes

### REQUIREMENTS / SPECIFICATIONS

<b>Compressed Air</b>	(up to)	<b>5 cfm</b>	<b>141.6 lpm</b>
<b>Water Pressure</b>		<b>400 - 1000 PSI</b>	<b>27.6 - 69.0 bar</b>
<b>Water Flow Rate</b>		<b>@ 700 PSI</b>	<b>@ 48.3 bar</b>
Hyper SS Foam		3.3 gpm	12.5 lpm
HPSS Foam		2.0 gpm	7.6 lpm
Rinse		5.0 gpm	18.9 lpm
<b>Discharge Hoses</b>			
ID - Hyper SS Foam		3/4 in.	19.1 mm
ID - HPSS Foam		1/2 in.	12.7 mm
ID - Rinse		3/8 in.	9.5 mm
Length (Foam/Rinse)		50 ft.	15.2 m

### Included

- Machined stainless steel foamer bodies
- Stainless steel mounting enclosure and ball valves
- Color-coded metering tips (20)
- Metering tip driver
- Two discharge hose assemblies:  
Foam: Hose with open flow, polypropylene foam wand and matching nozzle  
Rinse: Hose with rinse trigger gun, stainless steel wand and matching nozzle



Model #	Description
917118	Rinse / Hyper SS Foam HDS Complete
918118	Rinse / HPSS Foam HDS Complete
<b>Option</b>	
536500	Insulator For 1/4" SS Wand



Rinse trigger gun, stainless steel wand and matching fan nozzle

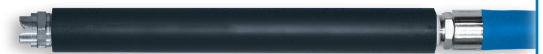

Open flow polypropylene foam wand and matching fan nozzle



Upgrade Option for 918118 listed this page: Stainless Steel Wand upgrade when ordering with unit. Request item # 536603-X.



Optional insulator for 1/4" stainless steel wand. Insulates hands from hot or cold extremes and provides comfortable secure grip.

## SANITIZE / FOAM HOSE DROP STATIONS

REQUIRES: 400-1000 / 2000 PSI WATER, COMPRESSED AIR

- For use with high pressure water systems, Lafferty stainless steel Sanitize / Foam Hose Drop Stations are convenient combination systems that will apply one chemical as foam and a second chemical as a sanitizing spray.
- The Lafferty W-20SS Sanitizer produces a medium volume spray.
- Choice of two foaming volumes.
- Foam throw distance of up to 13 ft. with included fan nozzle — Optional 0° nozzle available for greater foam throw distance.
- Covers up to 500 ft<sup>2</sup> (46.5m<sup>2</sup>) in 2 minutes

### REQUIREMENTS / SPECIFICATIONS

<b>Compressed Air</b>	(up to)	<b>5 cfm</b>	<b>141.6 lpm</b>
<b>Water Pressure</b>		<b>400 - 1000 PSI</b>	<b>27.6 - 69.0 bar</b>
<b>Water Flow Rate</b>		<b>@ 700 PSI</b>	<b>@ 48.3 bar</b>
Sanitize		3.1 gpm	11.7 lpm
Hyper SS Foam		3.3 gpm	12.5 lpm
HPSS Foam		2.0 gpm	7.6 lpm
<b>Discharge Hose</b>			
ID - Sanitize		3/8 in.	9.5 mm
ID - Hyper SS Foam		3/4 in.	19.1 mm
ID - HPSS Foam		1/2 in.	12.7 mm
Length (Sanitize/Foam)		50 ft.	15.2 m

### Includes

- Machined stainless steel foamer bodies
- Stainless steel mounting enclosure
- Stainless steel ball valves
- Color-coded metering tips (20)
- Metering tip driver
- Two discharge hose assemblies:  
Sanitize: High pressure hose, trigger gun, stainless steel wand and matching nozzle  
Foam: Hose, open flow polypropylene foam wand and matching nozzle



Model #	Description
917120	W-20SS Sanitize / Hyper SS Foam HDS
918120	W-20SS Sanitize / HPSS Foam HDS
918135	HPSS Foam / HPSS Foam HDS
918850	Portable W-20SS Sanitize / HPSS Foam HDS
<b>Option</b>	
536500	Insulator For 1/4" SS Wand



Sanitize trigger gun, stainless steel wand and matching fan nozzle

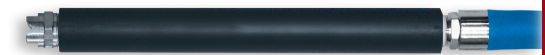

Open flow polypropylene foam wand and matching fan nozzle



Upgrade Option for 918120 listed this page: Stainless Steel Wand upgrade when ordering with unit. Request item # 536603-X.



Optional insulator for 1/4" stainless steel wand. Insulates hands from hot or cold extremes and provides comfortable secure grip.

HIGH PRESSURE

## SANITIZE/RINSE/FOAM HOSE DROP STATIONS

REQUIRES: 400-1000 PSI WATER, COMPRESSED AIR

- For use with high pressure water systems, Lafferty stainless steel Sanitize/Rinse/Foam Hose Drop Stations are convenient combination systems that will apply one chemical as foam, rinse, and apply a second chemical as a sanitizing spray.
- The Lafferty W-20SS Sanitizer produces a medium volume spray.
- Choice of two foaming volumes.
- Foam throw distance of up to 13 ft. with included fan nozzle. Optional 0° nozzle available for greater foam throw distance.
- Covers up to 500 ft<sup>2</sup> (46.5m<sup>2</sup>) in 2 minutes
- Quick disconnects allow one hose to be used for both sanitizing and rinse.
- Dedicated foam hose

### REQUIREMENTS / SPECIFICATIONS

<b>Compressed Air</b>	(up to)	<b>5 cfm</b>	<b>141.6 lpm</b>
<b>Water Pressure</b>		<b>400 - 1000 PSI</b>	<b>27.6 - 69.0 bar</b>
<b>Water Flow Rate</b>		<b>@ 700 PSI</b>	<b>@ 48.3 bar</b>
Sanitize		3.1 gpm	11.7 lpm
Hyper SS Foam		3.3 gpm	12.5 lpm
HPSS Foam		2.0 gpm	7.6 lpm
Rinse		8.4 gpm	31.8 lpm
<b>Discharge Hoses</b>			
ID - Sanitize/Rinse		3/8 in.	9.5 mm
ID - Hyper SS Foam		3/4 in.	19.1 mm
ID - HPSS Foam		1/2 in.	12.7 mm
Length		50 ft.	15.2 m

### Includes

- Machined stainless steel sanitizer and foamer bodies
- Stainless steel mounting enclosure
- Stainless steel ball valves
- Color-coded metering tips (20)
- Metering tip driver
- Two discharge hose assemblies:
  - Sanitize/rinse: High pressure hose with quick disconnects, trigger gun, stainless steel wand and matching nozzle
  - Foam: Hose, open flow polypropylene foam wand and matching nozzle



Model #	Description
917227	W-20SS Sanitize/Rinse/Hyper SS Foam HDS
918227	W-20SS Sanitize/Rinse/HPSS Foam HDS
<b>Option</b>	
536500	Insulator For 1/4" SS Wand

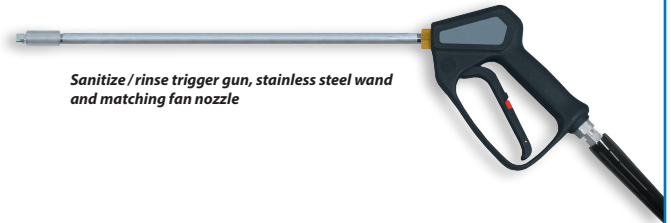

Sanitize /rinse trigger gun, stainless steel wand and matching fan nozzle



Open flow polypropylene foam wand and matching fan nozzle



Upgrade Option for 918227 listed this page: Stainless Steel Wand upgrade when ordering with unit. Request item # 536603-X.



Optional insulator for 1/4" stainless steel wand. Insulates hands from hot or cold extremes and provides comfortable secure grip.

## ACCESSORIES

In addition to supplying parts for all Lafferty equipment, Lafferty offers a range of convenient accessories to complement its wide range of chemical application equipment.

Stainless steel jug racks and hose racks can be used with many products, while Drum Sticks and Tote Sticks offer a convenient way to draw chemical from bulk containers. A water pressure / flow test kit provides guidance for equipment selection and when troubleshooting.

## STAINLESS STEEL JUG RACKS

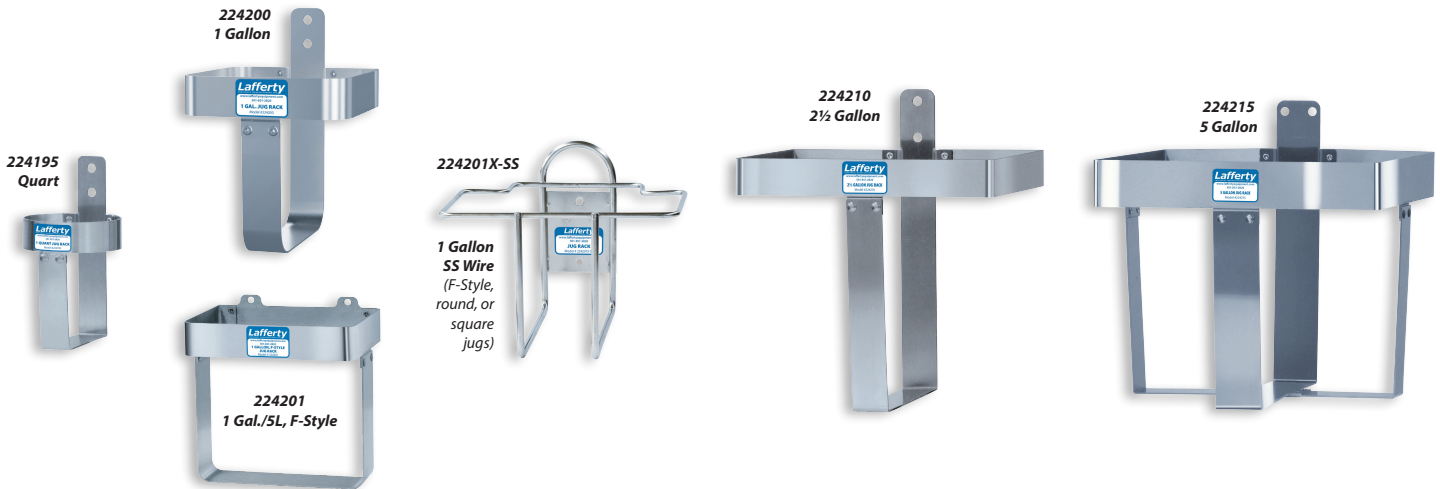

### DIMENSIONS

Model #		Diameter or Width x Depth	
224195	Quart	3 7/8 in. ID	9.8 cm ID
224200	1 Gal. Round/Sq.	6 1/2 x 6 3/8 in.	16.5 x 16.2 cm
224200-L	1 Gal. Rnd./Sq., Locking	6 1/2 x 6 3/8 in.	16.5 x 16.2 cm
224201	1 Gal./5L R'tangle, F-Style	7 5/8 x 5 7/8 in.	19.4 x 14.9 cm
224201X-SS	1 Gal. Wire, Rnd./Sq./F	8 x 6 3/8 in.	22.9 x 22.9 cm
224210	2 1/2 Gal.	10 5/8 x 8 1/2 in.	27.0 x 21.6 cm
224214	5 Gal. Rnd./Sq., Locking	13 x 12 6/8 in.	33.0 x 32.4 cm
224215	5 Gal. Rnd./Sq.	13 x 12 6/8 in.	33.0 x 32.4 cm

Model #	Description
224195	Jug Rack, SS, 1 Quart
224200	Jug Rack, SS, 1 Gallon Round/Square
224200-L	Jug Rack, SS, 1 Gallon Round/Square, Locking
224201	Jug Rack, SS, 1 Gallon/5 Litre Rectangular, F-Style
224201X-SS	Jug Rack, 1 Gallon SS Wire (Round/Square/F-Style)
224210	Jug Rack, SS, 2 1/2 Gallon
224214	Jug Rack, SS, 5 Gallon Round/Square, Locking
224215	Jug Rack, SS, 5 Gallon Round/Square

## LOCKABLE

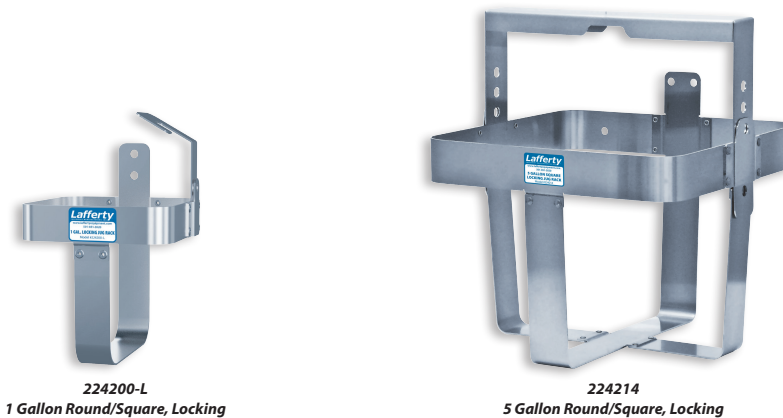

HIGH PRESSURE

## STAINLESS STEEL HOSE RACKS

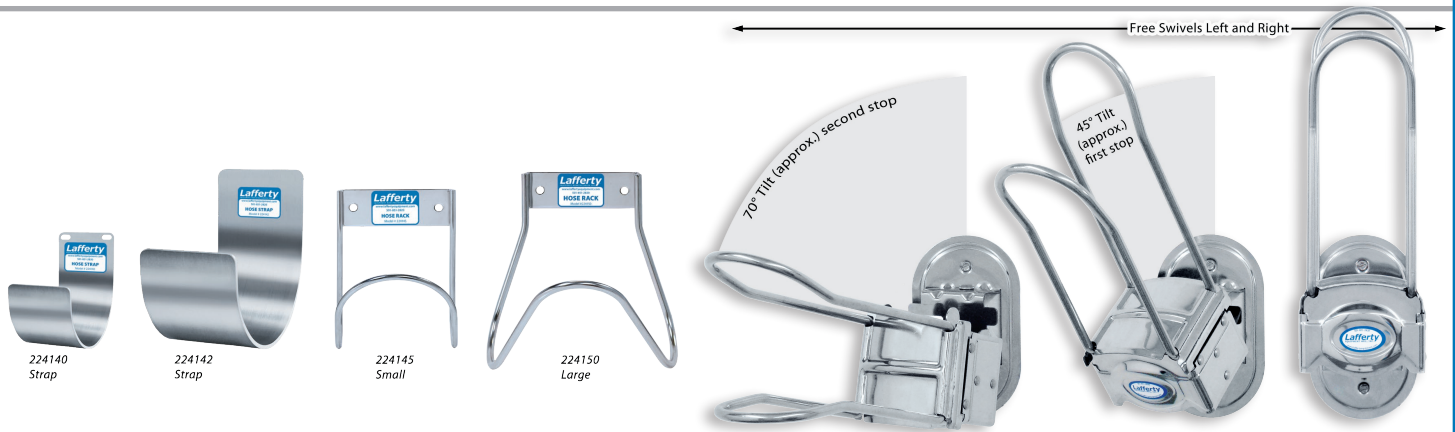

### HOSE CARRYING CAPACITY

Model #		Inside Diameter x Length	
224140	Strap	1/2 in. ID up to 75 ft. (+/-)	12.7 mm ID x 22.9 m (+/-)
224142	Strap, L	3/4 in. ID up to 75 ft. (+/-)	19.1 mm ID x 22.9 m (+/-)
224145	Small	3/4 in. ID up to 50 ft. (+/-)	19.1 mm ID x 15.4 m (+/-)
224150	Large	1 in. ID up to 75 ft. (+/-)	25.4 mm x 22.9 m (+/-)
224160	Tilt	3/4 in. ID up to 100 ft. (+/-)	19.1 mm ID x 30.5+ m (+/-)

Model #	Description
224140	Hose Strap, SS
224142	Hose Strap, SS, Large
224145	Hose Rack, SS, Small
224150	Hose Rack, SS, Large
224160	Hose Rack, SS, Large Tilt

## STAINLESS STEEL HOSE REELS

- This retractable reel features a full-port swivel that allows unrestricted foam output. Other reels may have ports with narrowed openings through the swivel, which compresses the foam, resulting in watery, inferior foam output.
- Use with confidence with a wide range of Lafferty sprayers/sanitizers and foamers that require 3/8" or 1/2" ID hose

### Features

- Stainless steel construction and a heavy-duty steel base ensure strength, safety, corrosion resistance, and durability
- Electro-Polished Stainless Steel finish
- Non-Corrosive Stainless Steel Fluid Path Featuring Stainless Steel Swivel
- Auto Rewind via a non-corrosive stainless steel cartridge-style spring motor easily wraps, stores and protects hose
- Adjustable hose stop prevents full hose retraction and allows for quick, easy access to hose-end tools
- Guide arm adjusts to wall, floor and overhead positions
- Pinch-proof, four-way, guide-arm rollers allow the hose to be pulled from the reel in any direction

### REQUIREMENTS / SPECIFICATIONS

<b>Water Pressure</b>	<b>up to</b>	<b>2500 PSI</b>	<b>172.4 bar</b>
<b>Discharge Hose ID</b>	<b>either</b>		
		3/8 in.	9.5 mm
		1/2 in.	12.7 mm

### Includes:

- 6' Lafferty-specified jumper hose (assures compatibility with Lafferty foamers and spray applicators)
- Heavy Gauge Steel/Stainless Steel Base and Support Post
- Stainless Steel Rollers
- Factory-Matched Cartridge-Style Spring Motor
- Multi-Position Lock Ratchet Secures Hose At Desired Length
- Rolled Edges and Ribbed Discs Provide Strength and Safety
- Leading 2-Year Manufacturer's Limited Warranty

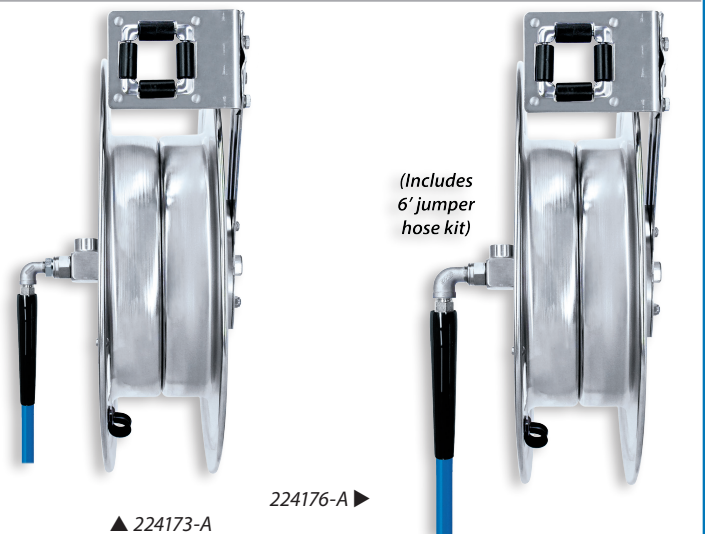

Model #	Description
224173-A	Hose Reel, SS, 3/8" x 50', 2500 PSI, With Jumper Hose Kit
224176-A	Hose Reel, SS, 1/2" x 50', 2500 PSI, With Jumper Hose Kit

<sup>†</sup>Allow six weeks production time. Discharge hose and applicator wand not included.

## DRUM STICK / TOTE STICK

- Chemical/acid resistant polypropylene construction
- Connects to chemical pick-up tubes fitted to any venturi applicator or chemical pumping system
- Drum Bung Adaptor, machined to fit either coarse or fine-threaded bung holes, and Tote Stick Cover, for larger openings on totes and other bulk containers, keep trash out of chemical and allow easy depth adjustment of the Drum or Tote Stick.
- Rigid pipe overcomes problems common with flexible tubing
- Hastelloy strainer easily accessible for cleaning
- Choice of Viton or EPDM seals

### SPECIFICATIONS

#### Polypropylene extension pipe

ID	3/4 in.	19.1 mm
Lengths:	Pipe Length	Inside Drum/Tote
33" Drum Stick	33 in. / 0.83 m	35 in. / 0.89 m
48" Drum Stick	48 in. / 1.22 m	50 in. / 1.27 m
54" Drum Stick	54 in. / 1.37 m	56 in. / 1.42 m
33" Tote Stick	33 in. / 0.8 m	36 in. / 0.91 m
48" Tote Stick	48 in. / 1.22 m	51 in. / 1.29 m
54" Tote Stick	54 in. / 1.37 m	57 in. / 1.45 m

#### Includes

- Machined polypropylene Drum Bung Adaptor with coarse and fine threads or 11" x 11" polypropylene Tote Stick Cover
- Four polypropylene hose barbs:
 

1/4 in.	6.3 mm
3/8 in.	9.5 mm
1/2 in.	12.7 mm
3/4 in.	19.0 mm
- Polypropylene chemical check valve
- Hastelloy chemical strainer

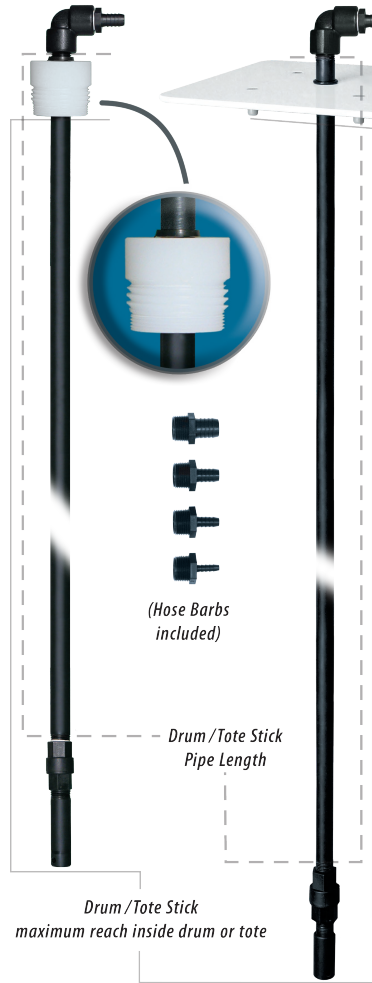

Model #	Description
491643	Drum Stick, 33" (Viton seals)
491643-E	Drum Stick, 33" (EPDM seals)
491644	4-Way Drum Stick, 33" (Viton seals)*
491644-E	4-Way Drum Stick, 33" (EPDM seals)*
491648	Drum Stick, 48" (Viton seals)
491648-E	Drum Stick, 48" (EPDM seals)
491649	4-Way Drum Stick, 48" (Viton seals)*
491645	Drum Stick, 54" (Viton seals)
491645-E	Drum Stick, 54" (EPDM seals)
491653	Tote Stick, 33" (Viton seals)
494653-E	Tote Stick, 33" (EPDM seals)
491654	Tote Stick, 48" (Viton seals)
491654-E	Tote Stick, 48" (EPDM seals)
491656	Tote Stick, 54" (Viton seals)
491656-E	Tote Stick, 54" (EPDM seals)

Custom lengths available on request

### CHEMICAL DISPENSING ACCESSORIES:

## SAFE FLOW™ JUG OR PAIL LIDS AND PAIL STICKS

- Safe and Convenient — Prevents splashing, reduces odor, and allows for quick replacement of chemical concentrate.
- **Jug / Pail Lids:** Machined polypropylene lids threaded to fit 1 gallon jugs and the pull-up spout of many 5 gallon pails.
- **Jug Lid** includes 1' of suction tubing. (Model 709101-R fits Rieke FLEXSPOUT® closures.) **Slip Stick** includes a sliding Jug Lid and fits containers up to 21" deep.
- **Pail Sticks:** Polypropylene sticks with sliding collars, threaded to fit 3/4" container lid knockouts.
- **Model 709105** includes a 16" Pail Stick and 5 gallon pail with lid.



# 709101 (various models)  
1 Gallon Safe Flow Lid w/  
Flexible Tube & Strainer

# 491610 - 5 Gallon  
Safe Flow Lid w/ Rigid  
Tube & Strainer

# 709105 - 5 Gallon Pail  
with Suction Stem

Safe Flow Pail Sticks  
# 491617 - 16" (above, left)  
# 491622 - 21" (above, right)

LAFFERTY CATALOG SERIES

• Food & Beverage Processing • Pharmaceutical • Agriculture • General Industrial Applications

**1 • Venturi Systems – City Water Pressure**

**2 • Venturi Systems – Boosted Pressure**

**3 • Venturi Systems – High Pressure**

**4 • Compressed Air Operated Systems**

**5 • Pump Fed Sanitizers, Foamers & Hose Drop Stations**

**6 • Entryway, Drain & Hand Sanitizing Systems**

**7 • Foggers and Fogging Systems**

**Chemical Application Equipment**

www.LaffertyEquipment.com  
8512 Oak Grove Road • North Little Rock, AR 72118  
Phone: 800-999-2820 / 501-851-2820 • Fax Orders: 800-699-3719

Special Applications

**8 • Asphalt Release, Acid/Corrosive & Solvent Systems**

**9 • Chemical Management Systems**

**10 • Vehicle Wash & Detailing Systems**

**11 • JanSan / Commercial / Residential Systems**

**12 • Supermarket / Deli / Small Area Cleaning Systems**

